

dyson

DC  
16 car+boat

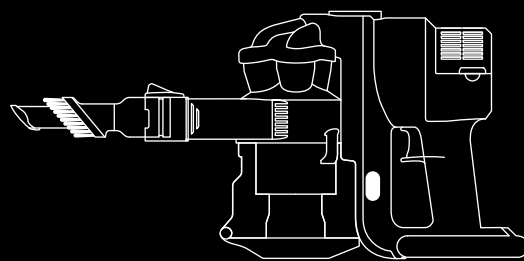

Box Contents

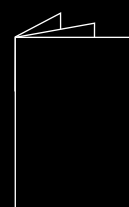
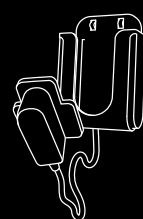
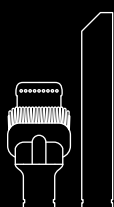
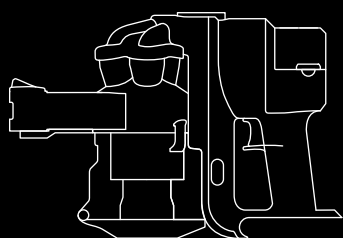

## IMPORTANT SAFETY INSTRUCTIONS

### READ ALL INSTRUCTIONS BEFORE USING THIS APPLIANCE

When using an electrical appliance, basic precautions should always be followed, including the following:



### WARNING

TO REDUCE THE RISK OF FIRE, ELECTRIC SHOCK OR INJURY:

1. Do not charge the unit where there is any possibility that the appliance or plug may get wet.
2. Do not use outdoors or on wet surfaces.
3. Use only the charger supplied with the product to recharge.
4. Do not allow to be used as a toy. Close attention is necessary when used by or near children.
5. This appliance is not intended for use by persons (including children) with reduced physical, sensory or mental capabilities, or lack of experience and knowledge, unless they have been given supervision or instruction concerning use of the appliance by a person responsible for their safety.
6. Use only as described in this manual. Use only Dyson recommended attachments.
7. Do not use with damaged cord or plug. If appliance is not working as it should, has been dropped, damaged, left outdoors, or dropped into water, contact the Dyson Helpline.
8. Do not use with an extension cord.
9. Do not unplug by pulling on cord. To unplug, grasp the plug, not the cord.
10. Do not handle charger, including the charger plug and charger terminals, with wet hands.
11. Do not put any object into openings. Do not use with any opening blocked; keep free of dust, lint, hair, and anything that may reduce air flow.
12. Keep hair, loose clothing, fingers, and all parts of body away from openings and moving parts.
13. Use extra care when cleaning on stairs.
14. Do not use to pick up flammable or combustible liquids, such as gasoline, or use in areas where they may be present.
15. Do not pick up anything that is burning or smoking, such as cigarettes, matches, or hot ashes.
16. Do not incinerate the appliance even if it is severely damaged. The batteries may explode in a fire.
17. Do not use without clear bin™ and filters in place.



### SAFETY WARNINGS FOR 12VOLT CHARGER

1. This charger is intended for dry location use only. Do not use or place the charger or machine where it may get wet.
2. Do not handle charger, including the charger plug and charger terminals with wet hands.
3. Do not leave the charger or appliance in direct sunlight.
4. The DC16 in-car charger is not intended for use by persons (including children) with reduced physical, sensory or mental capabilities, or lack of experience and knowledge, unless they have been given supervision or instruction concerning use of the appliance by a person responsible for their safety. Children should be supervised to ensure that they do not play with the charger.
5. This charger is intended for operation from 12Vdc negative earth electrical systems only.
6. Use only to charge the DC16 with genuine Dyson battery packs.
7. To remove the charger from the socket grasp the plug not the cord. Do not unplug by pulling on the cord.
8. Do not use the charger if the cord or plug is damaged or if the appliance is not working as it should be, has been dropped, damaged, left outdoors or dropped into water. Contact the Dyson Helpline 0800 298 0298.

# BATTERY SAFETY INSTRUCTIONS

Use only Dyson batteries and charging unit for this appliance.

The battery is a sealed unit and under normal circumstances poses no safety concerns. In the unlikely event that liquid leaks from the battery do not touch the liquid and observe the following precautions:

Skin contact – can cause skin irritation. Wash with soap and water.

Inhalation – can cause respiratory irritation. Provide fresh air and seek medical advice.

Eye contact – can cause eye irritation. Immediately flush eyes thoroughly with water for at least 15 minutes. Seek medical attention.

Disposal – wear gloves to handle the battery and dispose of immediately following local ordinances or regulations.

**CAUTION** – The battery used in this device may present a risk of fire or chemical burn if mistreated. Do not disassemble, short contacts, heat above 212°F (100°C), or incinerate. Replace battery with Dyson battery only, use of any other battery may present a risk of fire or explosion. Dispose of used battery promptly. Keep away from children. Do not disassemble and do not dispose of in fire.



Remove battery pack for disposal.

Do not dispose of battery pack in normal household waste.

Dispose of battery pack safely in accordance with local regulations.



Do not use near naked flame.



Do not use near heat source.



Do not pick up water or liquids.



Do not pick up burning objects.

## Optional accessory tool kit

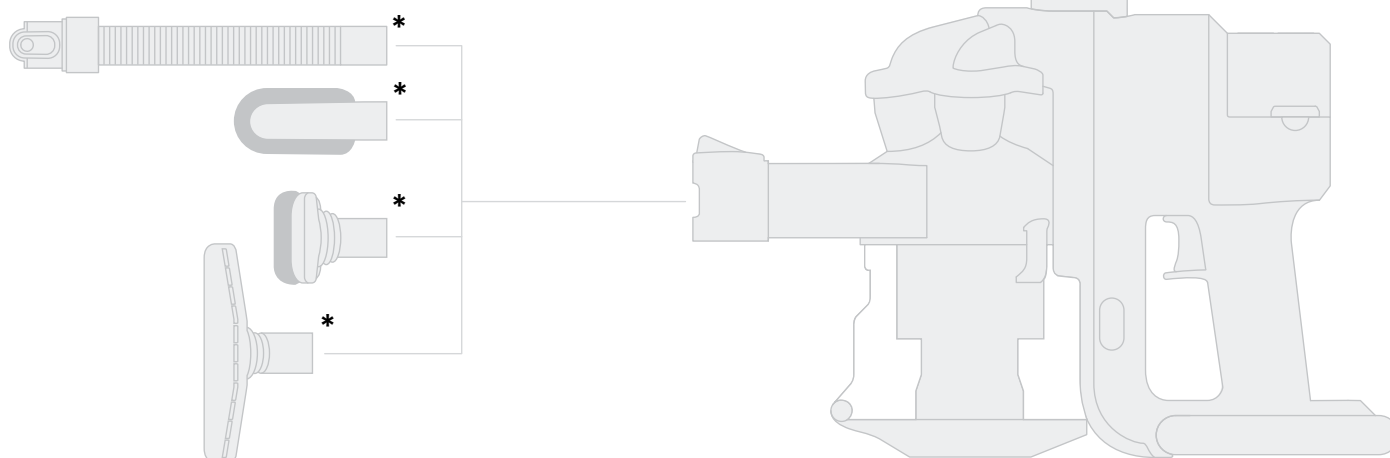

\* Available via [www.dyson.com](http://www.dyson.com) or your local Dyson retailer.

# Filters

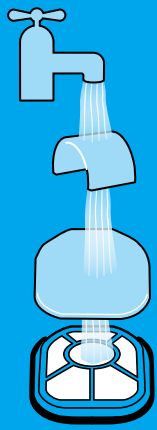

# 3-6

months

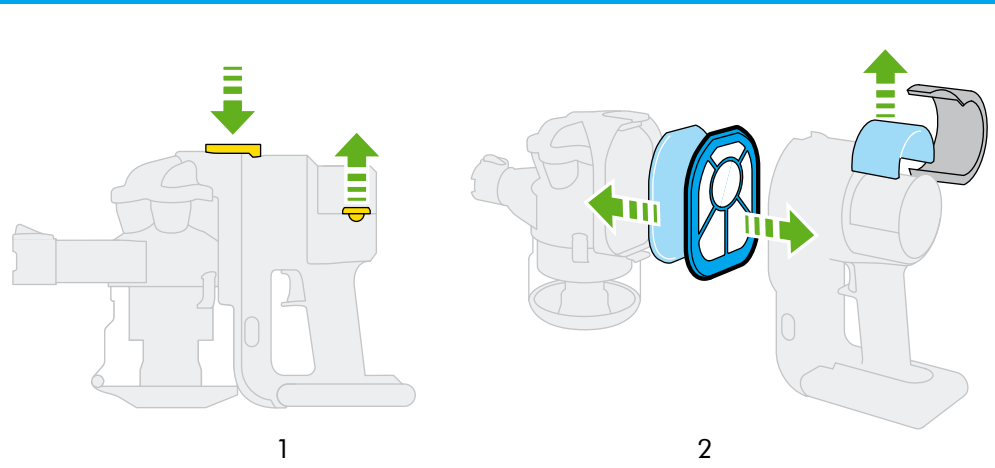

# Tools

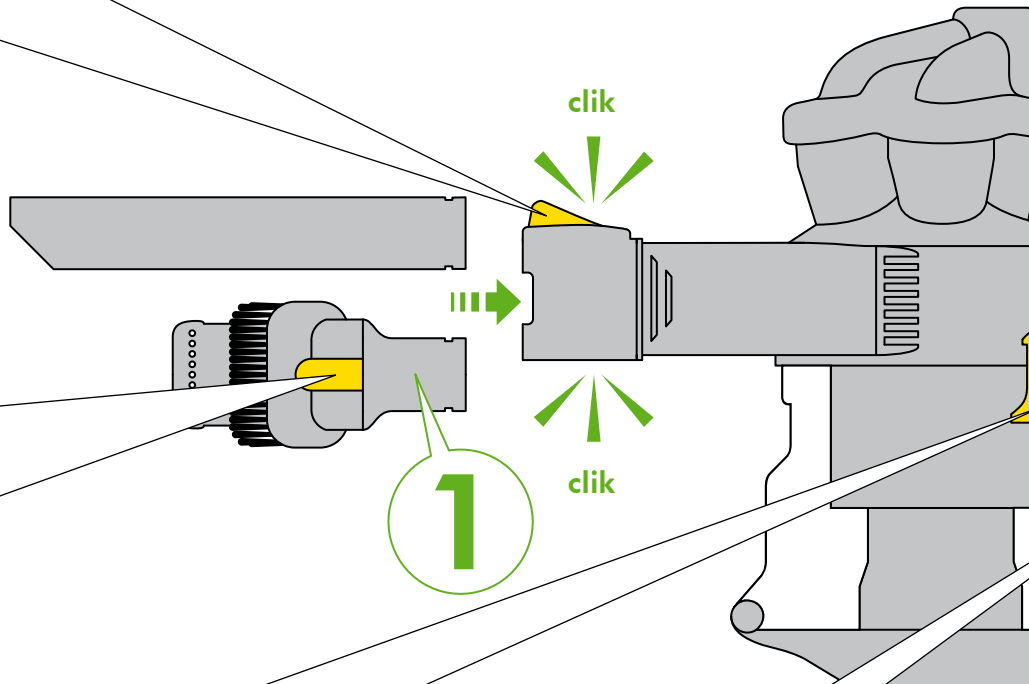
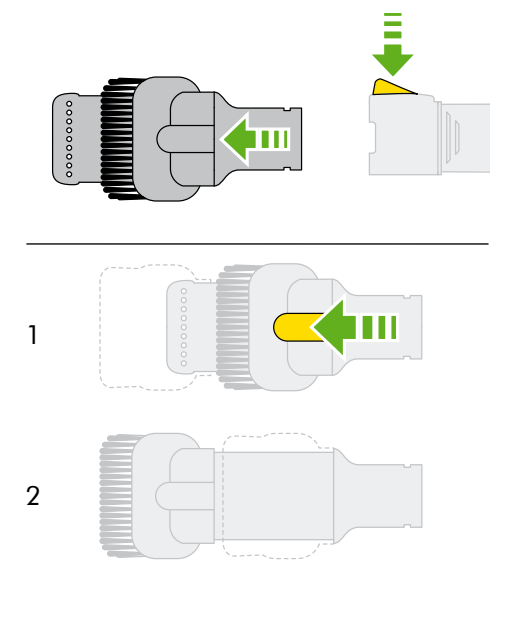

# Blockages

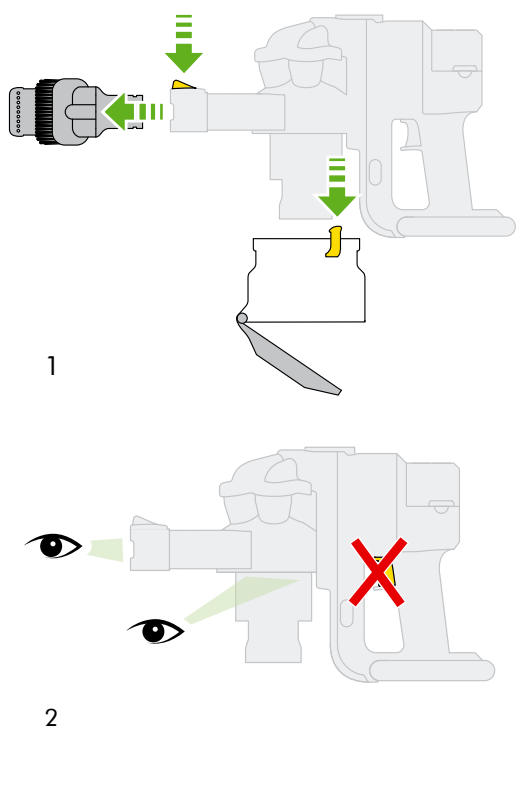

# Emptying

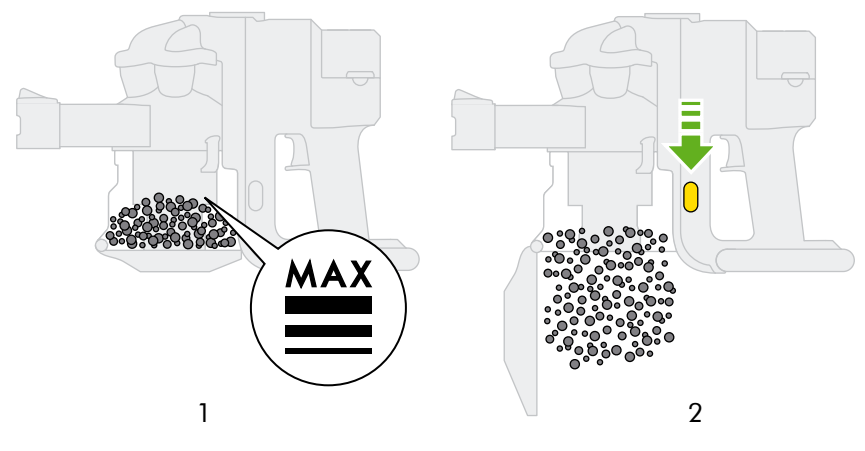

# In car c

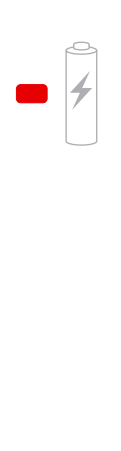

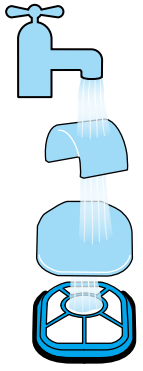

3

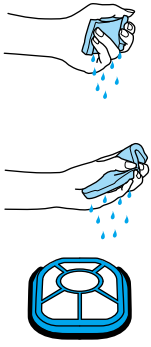

4

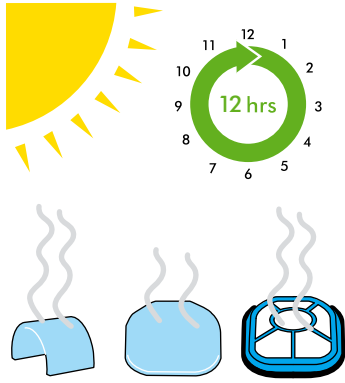

5

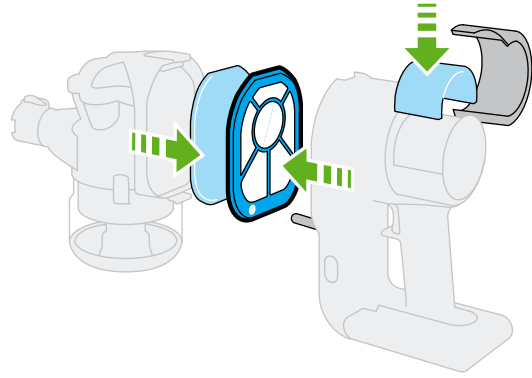

6

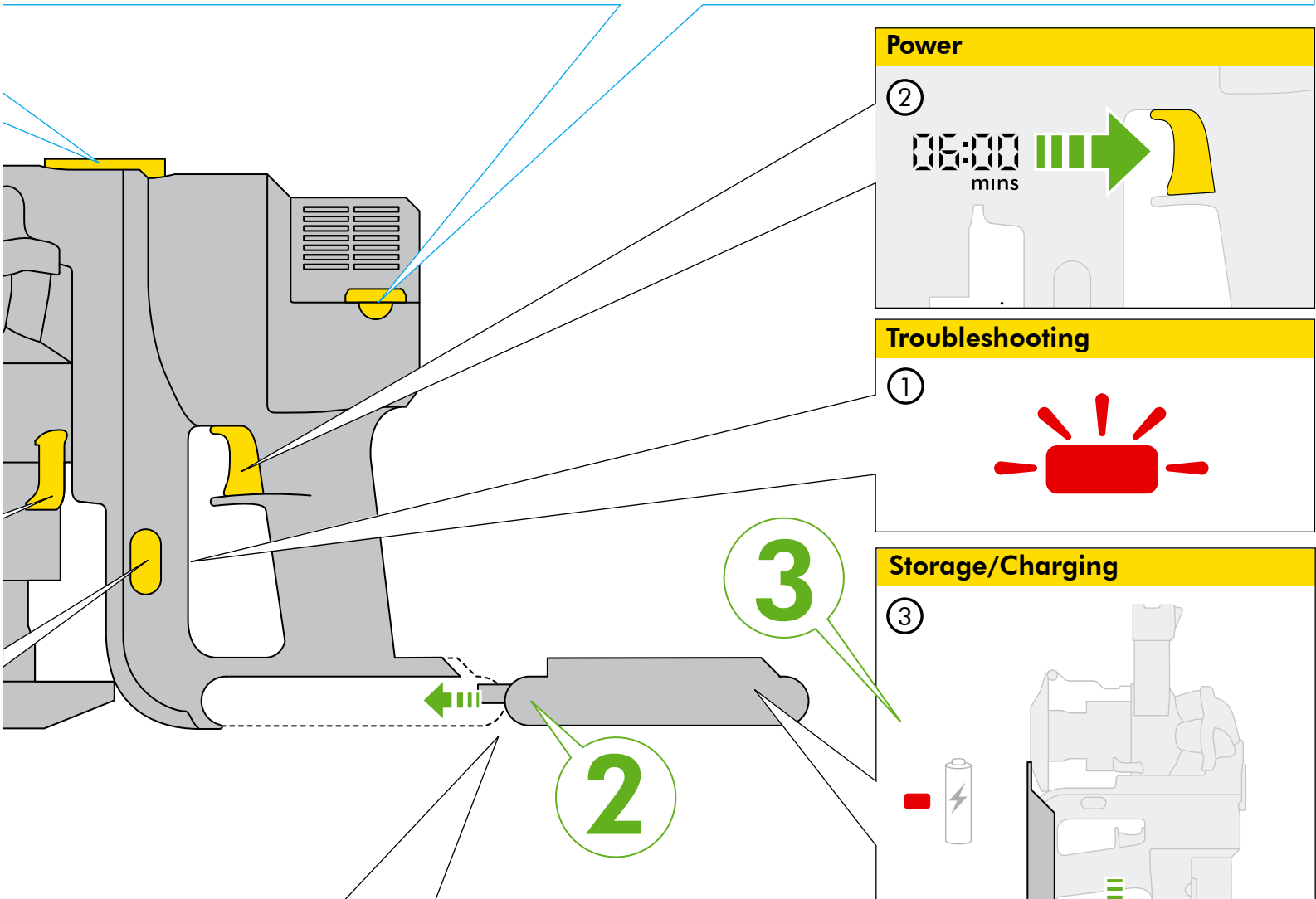

**Power**

②

05:00 mins

**Troubleshooting**

①

**Storage/Charging**

③

05:00 mins

3 hrs

**Car charger**



05:00 mins

3 hrs

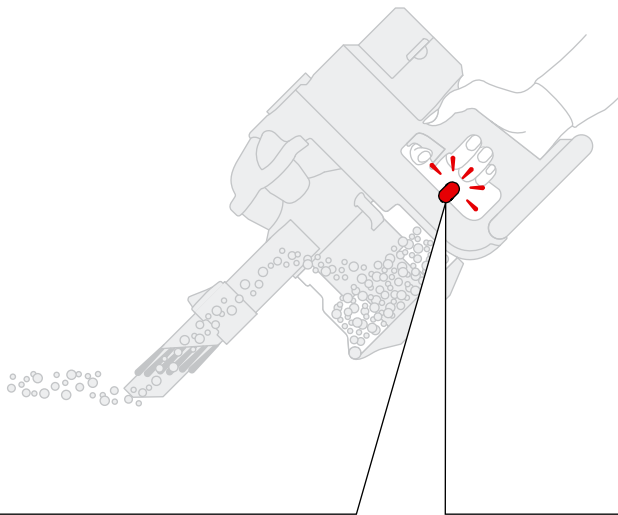

## Troubleshooting

①

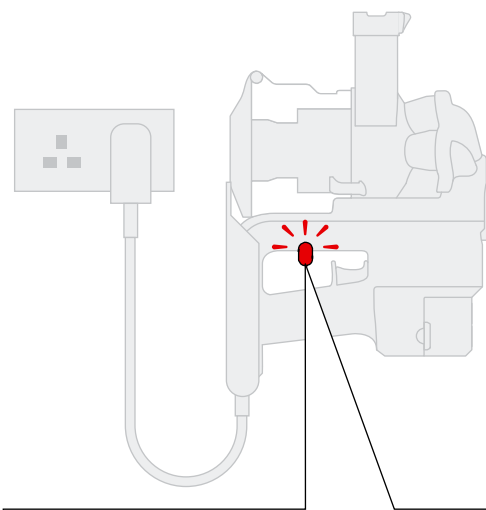

-  Fully or partly charged.
-  Fully discharged.
-  Filter missing/Filter fitted incorrectly. Check/Refit Filter.  
or  
Machine outside of temperature range. Leave at room temperature until flashing stops.



-  Fully charged.
-  Machine charging.
-  Battery outside of temperature range. Remove from the charger and leave at room temperature until red light no longer flashes when placed in the charger.  
or  
Charging fault. Remove appliance and refit to the recharging unit.

If flashing persists call the Dyson Helpline.

- ②
  - 1 When using the appliance, the light on the handle indicates the level of charge. A green light indicates the battery is fully or partly charged. A red light indicates the battery is fully discharged and needs charging.
  - 2 The battery will become hot during use – this is normal.
  - 3 The appliance will cut out immediately when the battery has run out – recharge for continued use.
- ③
  - 1 To ensure your appliance is always ready to use, store it on the charger.
  - 2 When connected to the charge, a red light indicates the battery is charging. A green light indicates the battery is fully or partly charged. Full charging takes around 3 hours.
  - 3 For optimum battery life always charge above 59°F, 15°C.
  - 4 Your Dyson battery comes partly charged. For full run time of 6 minutes, you should charge for 3 hours prior to use.

## Using your Dyson Handheld appliance

### Caution:

- 1 When wall mounting the recharging unit, always use the appropriate fixings for your wall type.
- 2 Check that there is no pipework or wiring directly behind the mounting/drilling area.
- 3 Dirt and debris may be released from the appliance if it is turned upside down. Ensure the appliance remains upright in use and store in the recharging unit.
- 4 Do not operate the appliance while checking for blockages.

### Please note:

- Do not carry out any maintenance or repair work other than that shown in this manual or advised by the Dyson Helpline.
- This appliance is designed for domestic use only. Do not use whilst the vehicle is in motion or while driving.
- Do not press down on the nozzle with excessive force when using the appliance as this may cause damage.
- If the motor overheats, the appliance will cut out automatically. Leave to cool for at least an hour and check for blockages before restarting.
- Fine dirt such as flour or plaster dust should only be vacuumed in very small amounts.

## Dyson Customer Care

If you have a query about your Dyson appliance call the Dyson Helpline quoting the serial number, or contact us via the Dyson website. The serial number can be found behind the clear bin™.

Most queries can be solved over the phone by one of our Helpline staff.

If your Dyson appliance needs a service, call the Dyson Helpline so we can discuss the available options. If your appliance is under warranty, and the repair is covered, it will be repaired at no cost.

## Customer Care details

Any queries – just call the Dyson Helpline.

UK 0800 298 0298

IRL 01 475 7109

[www.dyson.com](http://www.dyson.com)

## Thank you for choosing to buy a Dyson appliance

To help us ensure you receive prompt and efficient service, please register as a Dyson owner by completing the enclosed form and returning it to us by mail.

This product is protected by the following intellectual property rights:

### PATENT/PATENT APPLICATION NUMBERS:

CA 2,439,032; AU 2002-229966; EP 1361812; JP 2004-537336; US 2004/0128789; GB 2407784; WO 2005/053855; AU 2002226556; CA 2,439,250; EP 1370172; JP 2004-528876; US 2004-0074213; AU 2002225207; CA 2,438,069; EP 1361814; JP 2004-520137; US 2004-0112022; AU 2001240894; EP 1268076; JP 2003-528704; US 6,835,222; AU 2002-225232; CA 2,438,079; EP 1361815; JP 2004-520139; US 6,974,488; AU 637 272; EP 0636338; JP 1948 863; US 5,078,761; GB 2413974; WO 2005/110608; AU 2003-202714; CA 2,476,428; EP 1474242; GB 2385292; JP 2003-567583; US 2005-010229892; GB 0614238.4; GB 0614235.0; GB 0614237.6.

### DESIGNS/DESIGN APPLICATIONS:

GB 3025398; GB 3025399; GB 3025400; GB 3025401; GB 3025402; GB 3025403; GB 3025404; AU 313229; CA 118694; CN 200730001389.2; JP 2007-602; KR 30-2006-0050978; MY 07-00058-0101; RU 2007500128; US 29/271,387; AU 313284; CA 118696; JP 2007-603; KR 30-2006-0050979; US 29/271,386; AU 313208; CA 118695; JP 2007-604; KR 30-2006-0050980; US 29/271,388; AU 15953/2006; CA 118699; JP 2007-605; KR 30-2006-0050981; MY 07-00059-0101; RU 2007500130; US 29/271,389; ED 000651849-0001; AU 15952/2006; CA 118697; JP 2007-389; KR 30-2006-0050982; US 29/271,390; AU 313281; CA 118698; CN 200730001387.3; JP 2007-390; KR 30-2006-0050983; US 29/271,391; CN 200730001386.9; MY 06-00996; RU 2007500131; CN 20073001385.4; MY 06-00996; RU 2007500129; CN 200730001384; MY 06-00995; RU 2007500132.

Please note: Small details may vary from those shown.

# IMPORTANT!

## WASH FILTERS



Wash filters with cold water at least every 3-6 months.



GB Ask Dyson Helpline  
askdyson@dyson.co.uk  
0800 298 0298  
Dyson Ltd, Tetbury Hill,  
Malmesbury, Wiltshire SN16 0RP

IRL Dyson Customer Care  
askdyson@dyson.co.uk  
01 475 7109  
Dyson Ireland Limited, Unit G10,  
Grants Lane, Greenogue Business Park,  
Rathcoole, Dublin 24