

ASSEMBLY

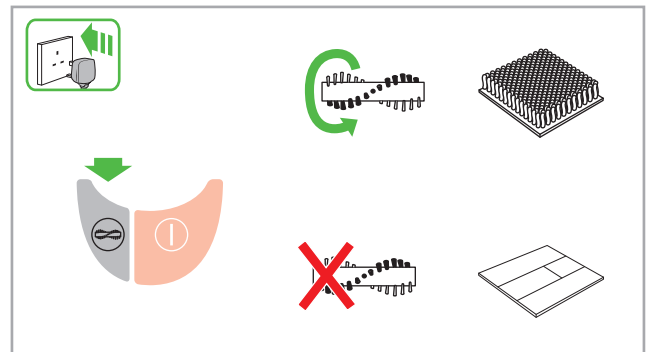
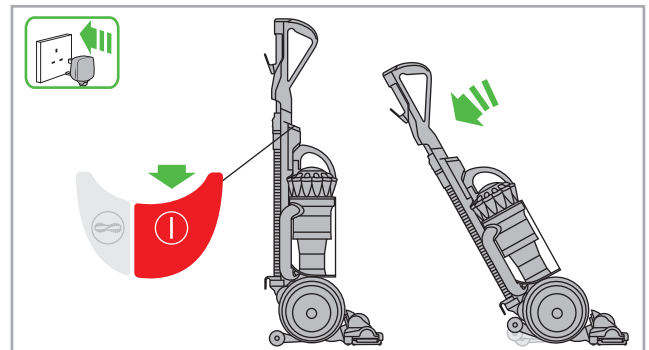
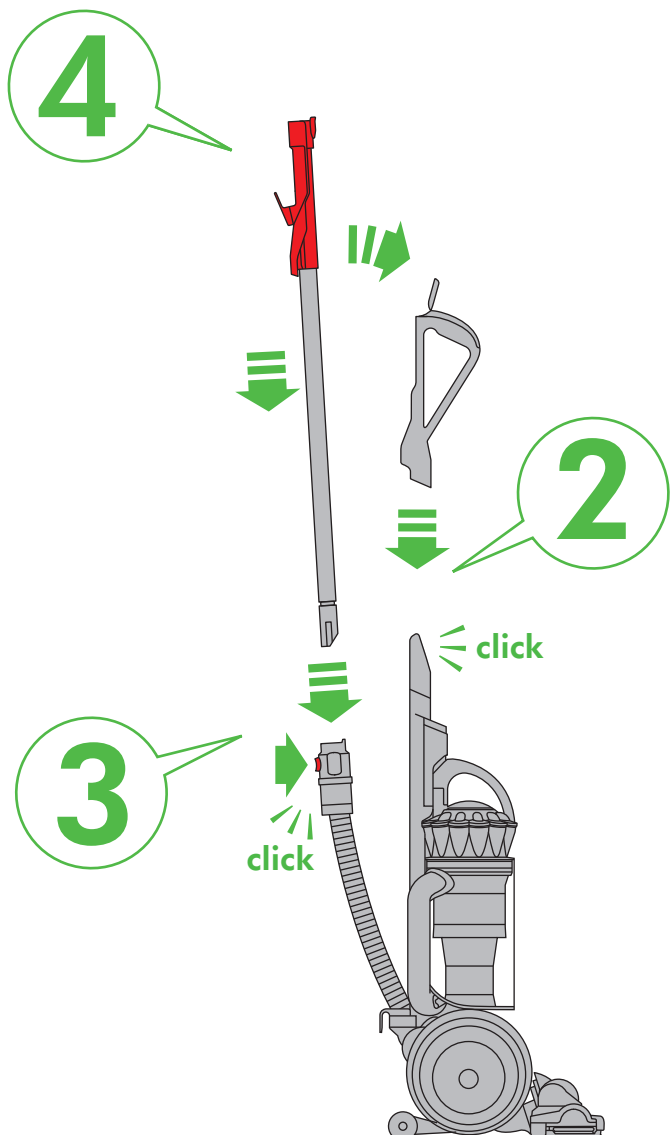
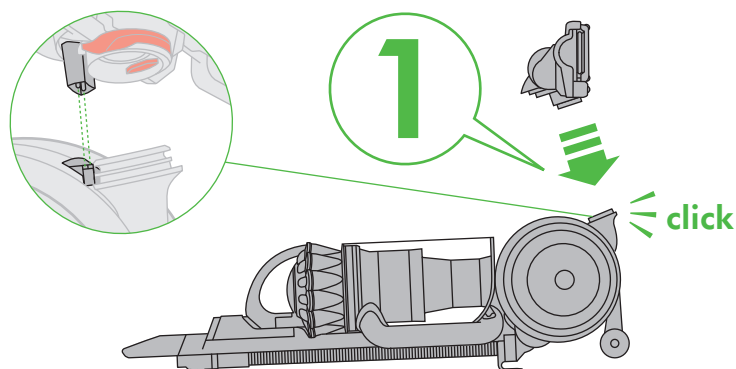

 **3**
months

WASH FILTERS

Wash filters with cold water at least every 3 months.



**REGISTER
YOUR FREE
5 YEAR
GUARANTEE
TODAY**



DYSON CUSTOMER CARE

THANK YOU FOR CHOOSING TO BUY A DYSON APPLIANCE

After registering your free 5 year guarantee, your Dyson appliance will be covered for parts and labour for 5 years from the date of purchase, subject to the terms of the guarantee.

If you have any questions about your Dyson appliance, call the Dyson Helpline with your serial number and details of where/when you bought the appliance.

Most questions can be solved over the phone by one of our trained Dyson Helpline staff.

Alternatively, visit www.dyson.co.uk/support for online help, general tips and useful information about Dyson.

Your serial number is on the rating plate which will be either (a) behind the clear bin or (b) on the top of the appliance above the switches, under the wand handle.

Note your serial number for future reference

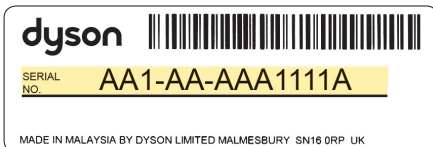

This illustration is for example purposes only.

DYSON CONTACT DETAILS

Website: www.dyson.co.uk/support

UK:

Dyson Helpline: UK: 0800 298 0298

Open 7am–10pm. 7 days a week.

Email: askdyson@dyson.co.uk

Address: Dyson Limited, Tetbury Hill, Malmesbury, Wiltshire SN16 0RP England.

ROI:

Dyson Helpline: ROI: 01 475 7109

Open 7am–10pm. 7 days a week.

Email: askdyson@dyson.co.uk

Address: Unit 10, Grants Lane, Greenogue Business Park, Rathcoole, Dublin 24.

3 EASY WAYS TO REGISTER YOUR FREE 5 YEAR GUARANTEE

REGISTER ONLINE



Visit our website to register your full parts and labour guarantee online.

www.dyson.co.uk/register
www.dyson.ie/register

REGISTER BY PHONE



Call our dedicated Helpline
Open 7am–10pm.
7 days a week.

UK 0800 298 0298
ROI 01 475 7109

REGISTER BY MAIL



Complete and return the form to Dyson in the envelope supplied.

IMPORTANT SAFETY INSTRUCTIONS

BEFORE USING THIS APPLIANCE READ ALL INSTRUCTIONS AND CAUTIONARY MARKINGS IN THIS MANUAL AND ON THE APPLIANCE

When using an electrical appliance, basic precautions should always be followed, including the following:

WARNING

TO REDUCE THE RISK OF FIRE, ELECTRIC SHOCK, OR INJURY:

1. This Dyson appliance is not intended for use by young children or infirm persons with reduced physical, sensory or reasoning capabilities, or lack of experience and knowledge, unless they have been given supervision or instruction by a responsible person concerning use of the appliance to ensure that they can use it safely.
2. Do not allow to be used as a toy. Close attention is necessary when used by or near children. Children should be supervised to ensure that they do not play with the appliance.
3. Use only as described in this Dyson Operating Manual. Do not carry out any maintenance other than that shown in this manual, or advised by the Dyson Helpline.
4. Suitable for dry locations only. Do not use outdoors or on wet surfaces.
5. Do not handle any part of the plug or appliance with wet hands.
6. Do not use with a damaged cable or plug. If the supply cable is damaged it must be replaced by Dyson, its service agent or similarly qualified person in order to avoid a hazard.
7. If the appliance is not working as it should, has received a sharp blow, has been dropped, damaged, left outdoors, or dropped into water, do not use and contact the Dyson Helpline.
8. Contact the Dyson Helpline when service or repair is required. Do not disassemble the appliance as incorrect reassembly may result in an electric shock or fire.
9. Do not stretch the cable or place the cable under strain. Keep the cable away from heated surfaces. Do not close a door on the cable, or pull the cable around sharp edges or corners. Arrange the cable away from traffic areas and where it will not be stepped on or tripped over. Do not run the appliance over the cable.
10. Do not unplug by pulling on the cable. To unplug, grasp the plug, not the cable. The use of an extension cable is not recommended.
11. Do not use to pick up water.
12. Do not use to pick up flammable or combustible liquids, such as petrol, or use in areas where they or their vapours may be present.
13. Do not pick up anything that is burning or smoking, such as cigarettes, matches, or hot ashes.
14. Keep hair, loose clothing, fingers, and all parts of body away from openings and moving parts, such as the brush bar. Do not point the hose, wand or tools at your eyes or ears or put them in your mouth.
15. Do not put any object into openings. Do not use with any opening blocked; keep free of dust, lint, hair, and anything that may reduce airflow.
16. Use only Dyson recommended accessories and replacement parts.
17. To avoid a tripping hazard rewind the cable when not in use.
18. Do not use without the clear bin and filters in place.
19. Do not leave the appliance when plugged in. Unplug when not in use and before servicing.
20. Do not pull or carry by cable or use cable as a handle.
21. Use extra care when cleaning on stairs. Do not work with the appliance above you on the stairs.
22. Turn off all controls before unplugging.

READ AND SAVE THESE INSTRUCTIONS

THIS DYSON APPLIANCE IS INTENDED FOR HOUSEHOLD USE ONLY

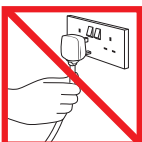

Do not pull on the cable.

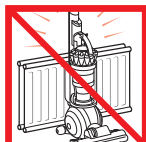

Do not store near heat source.



Do not use near naked flame.



Do not run over the cable.



Do not pick up water or liquids.

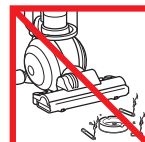

Do not pick up burning objects.



Do not use above you on the stairs.



Do not put hands near the brush bar when the appliance is in use.

Operation

Storage

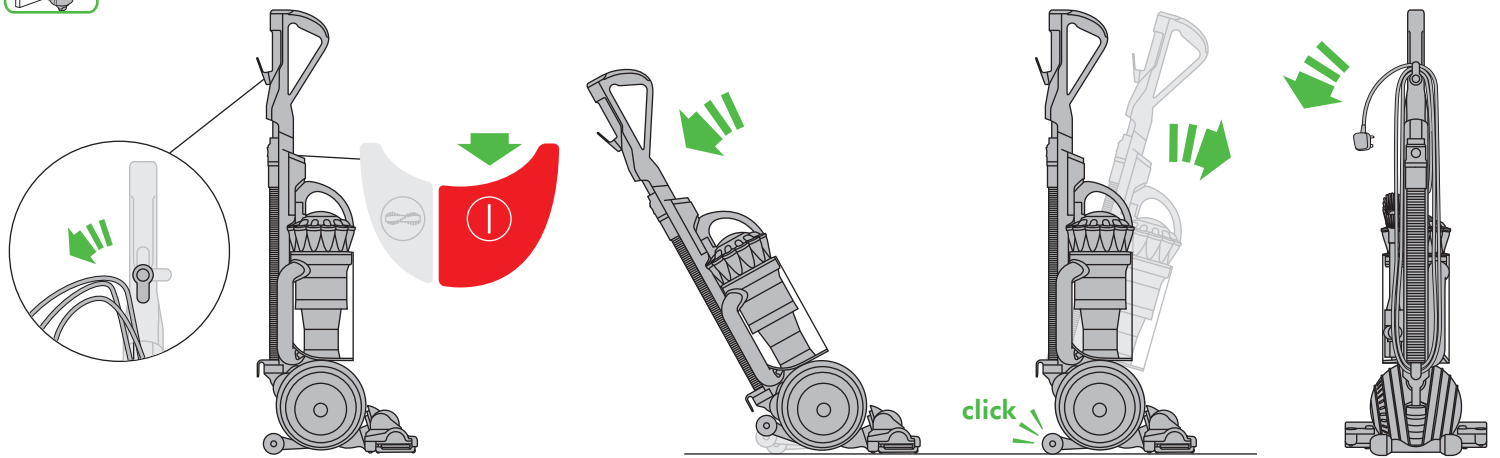

Emptying the clear bin

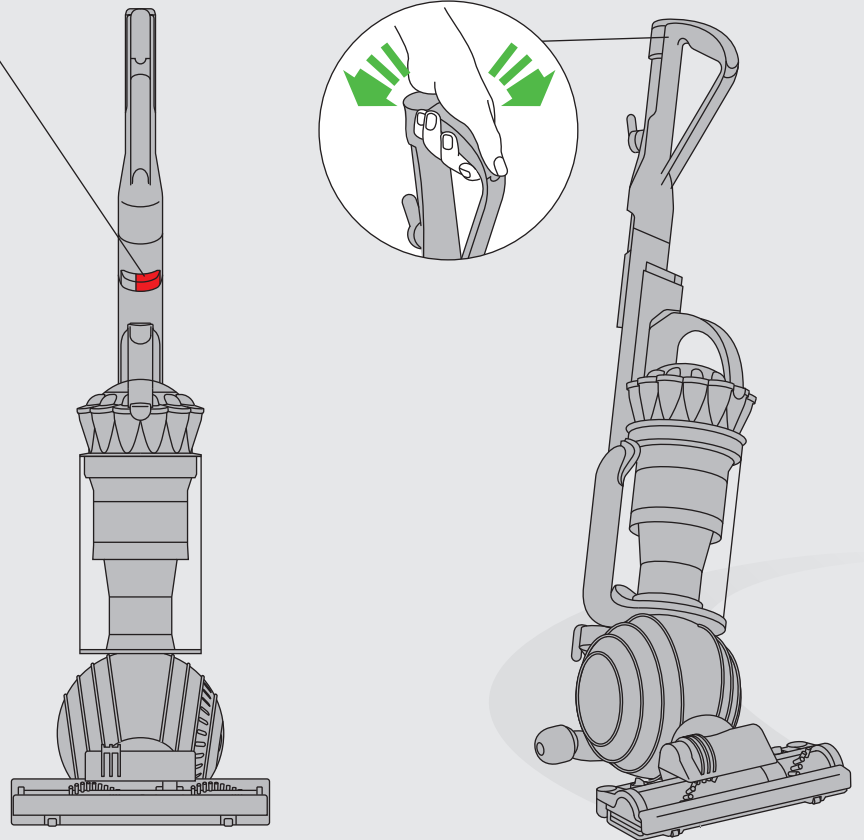
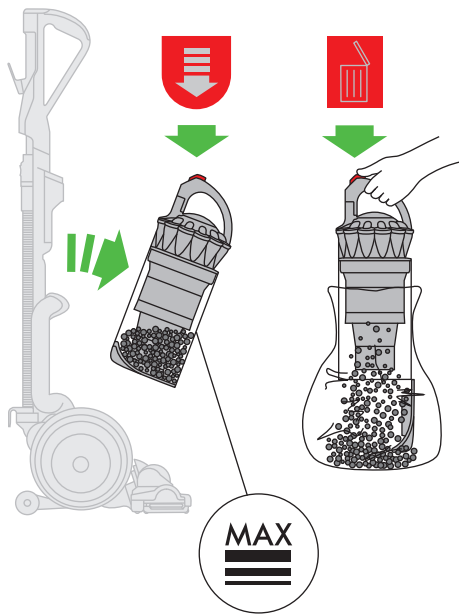
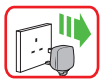

Looking for blockages

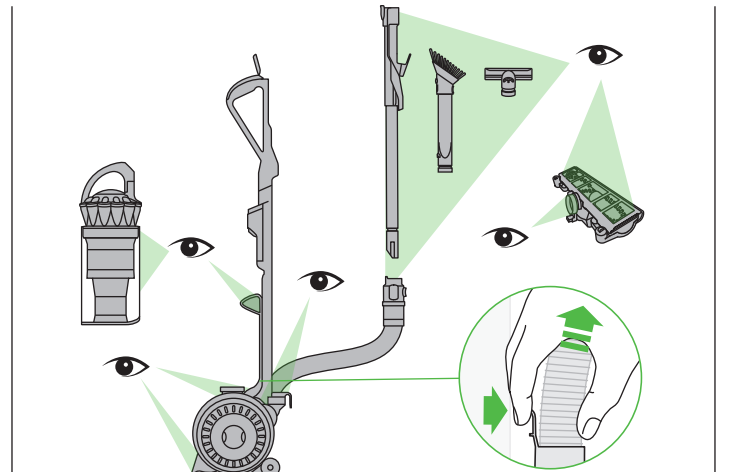
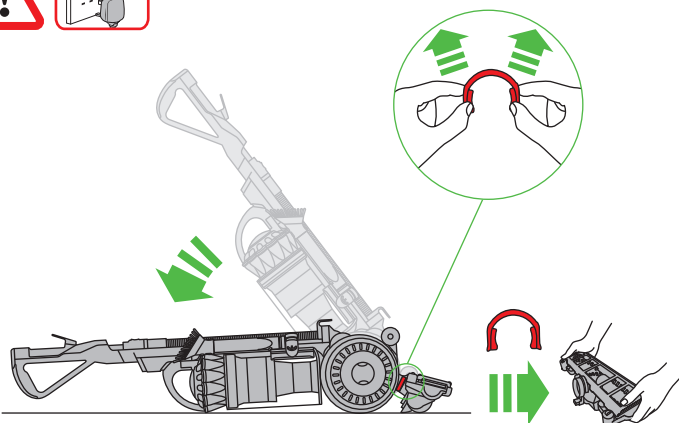

Carrying the appliance

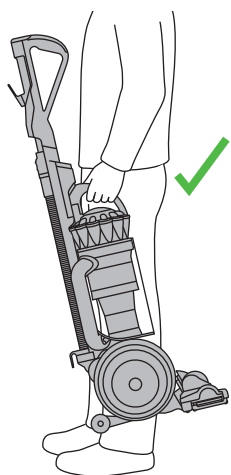

Carpets or hard floors

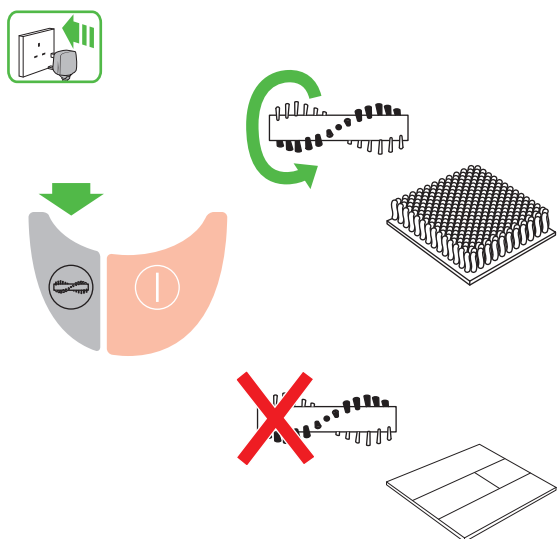

Attachments

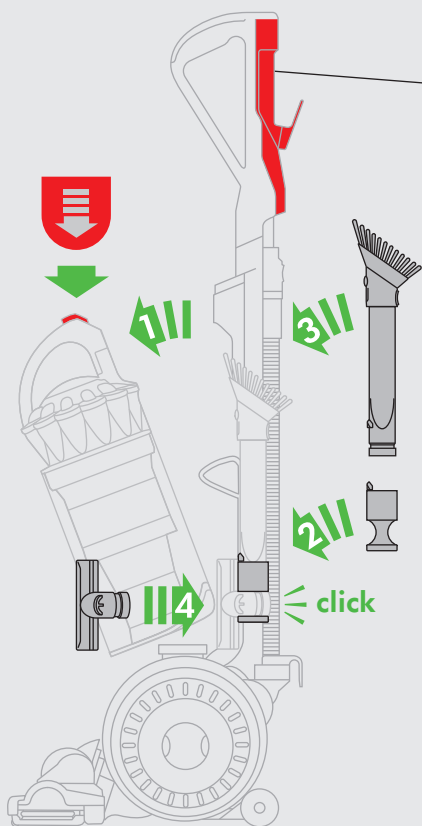
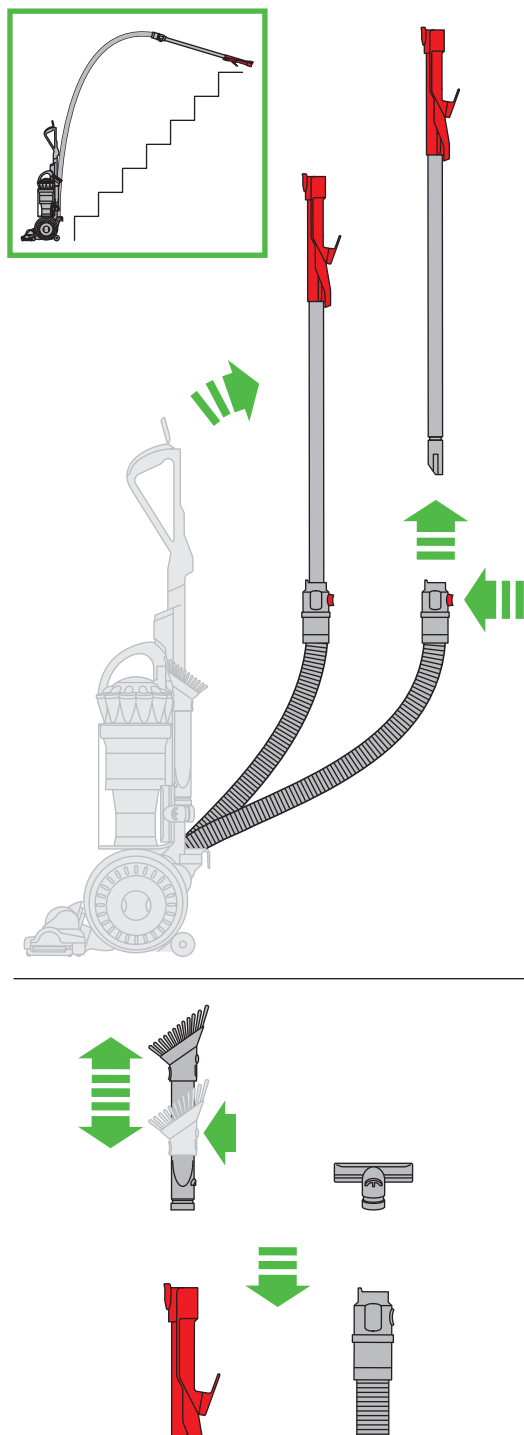

Brush bar – clearing obstructions

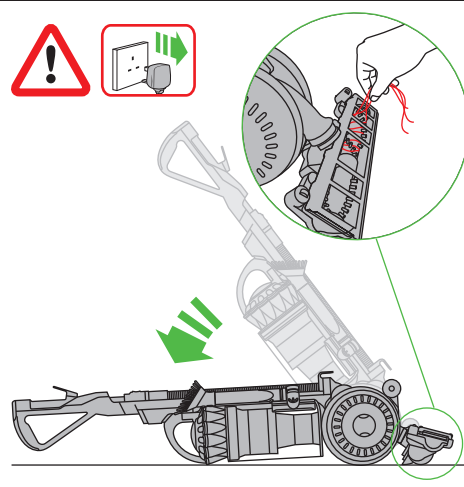
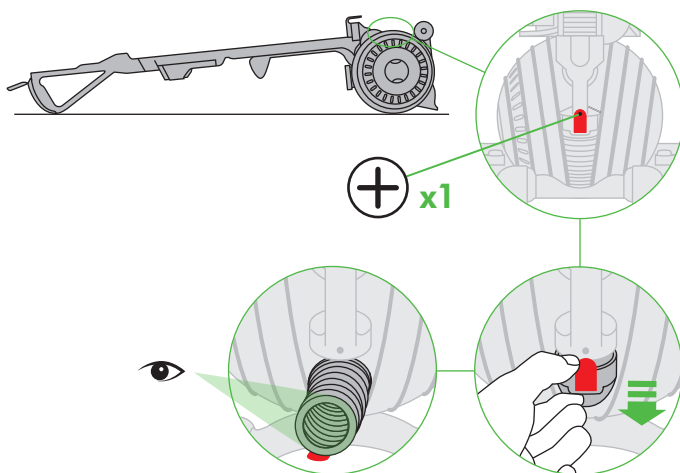
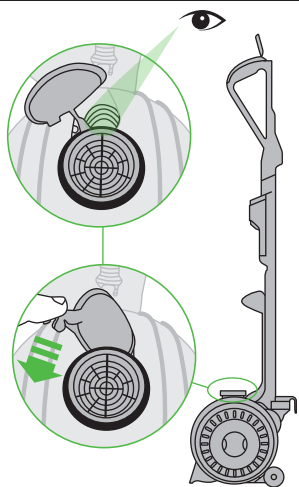

IMPORTANT!

WASH FILTERS

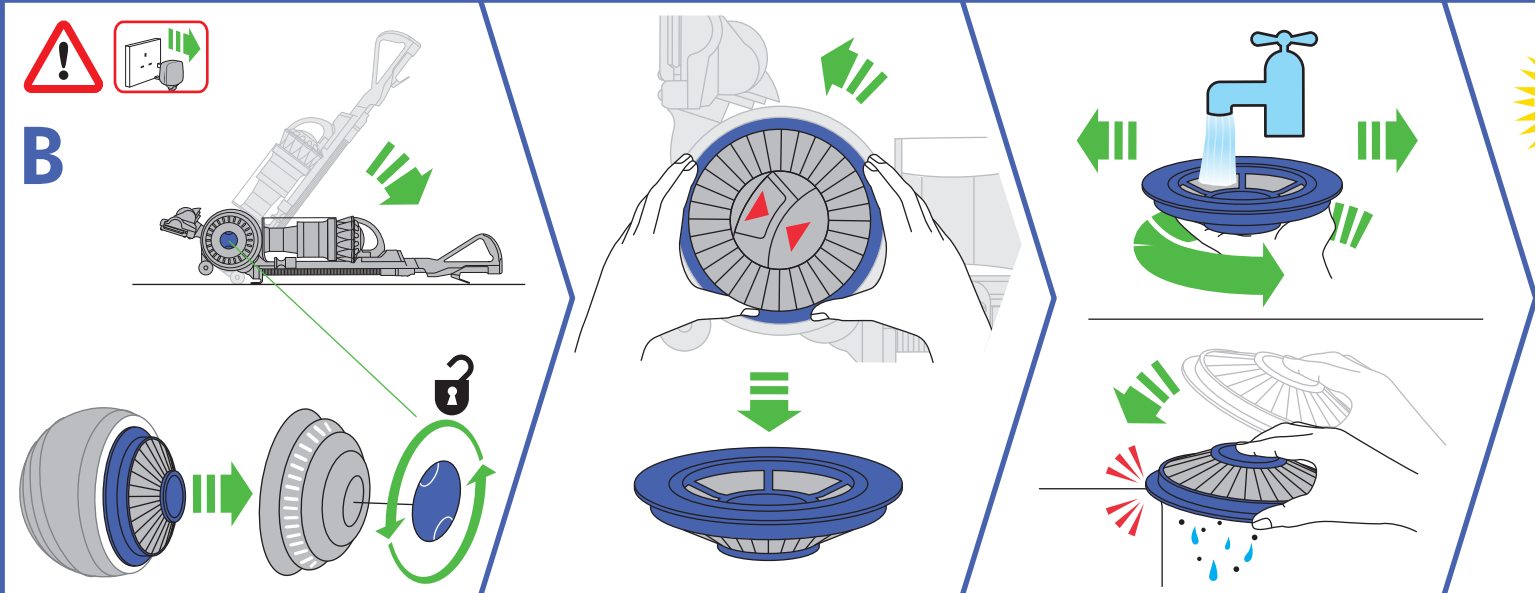
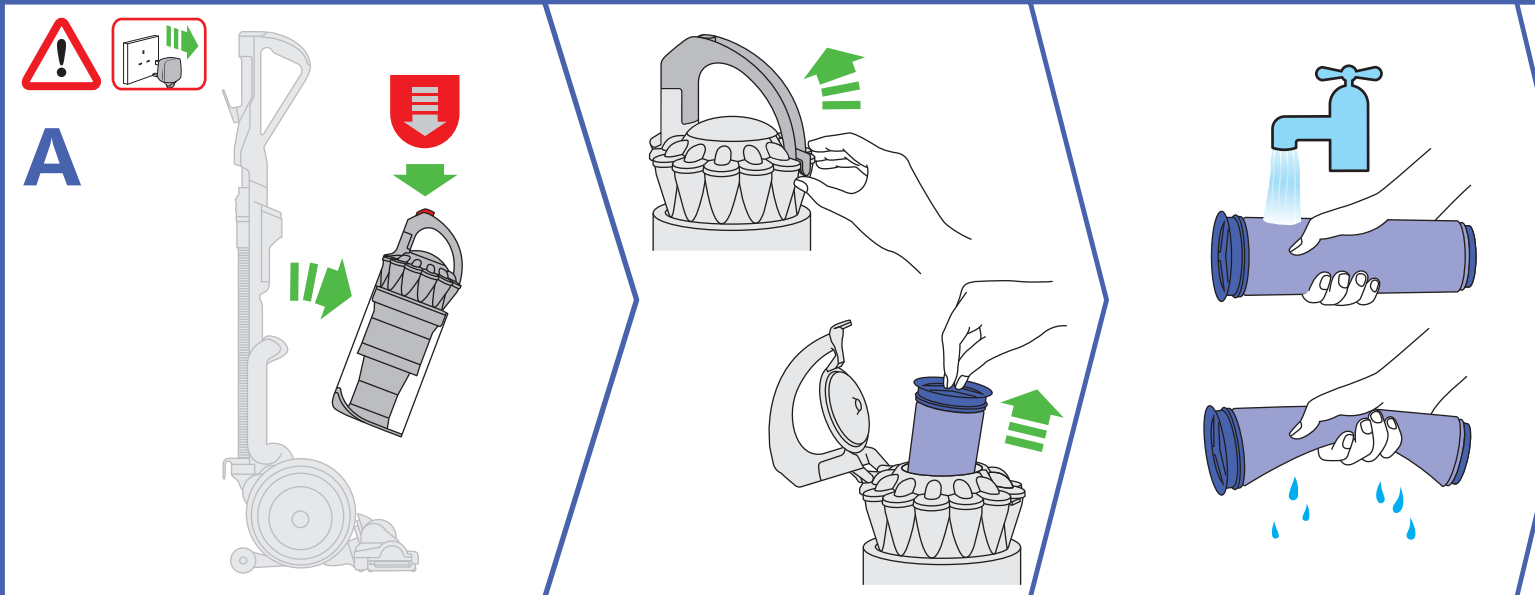

Base plate disassembly

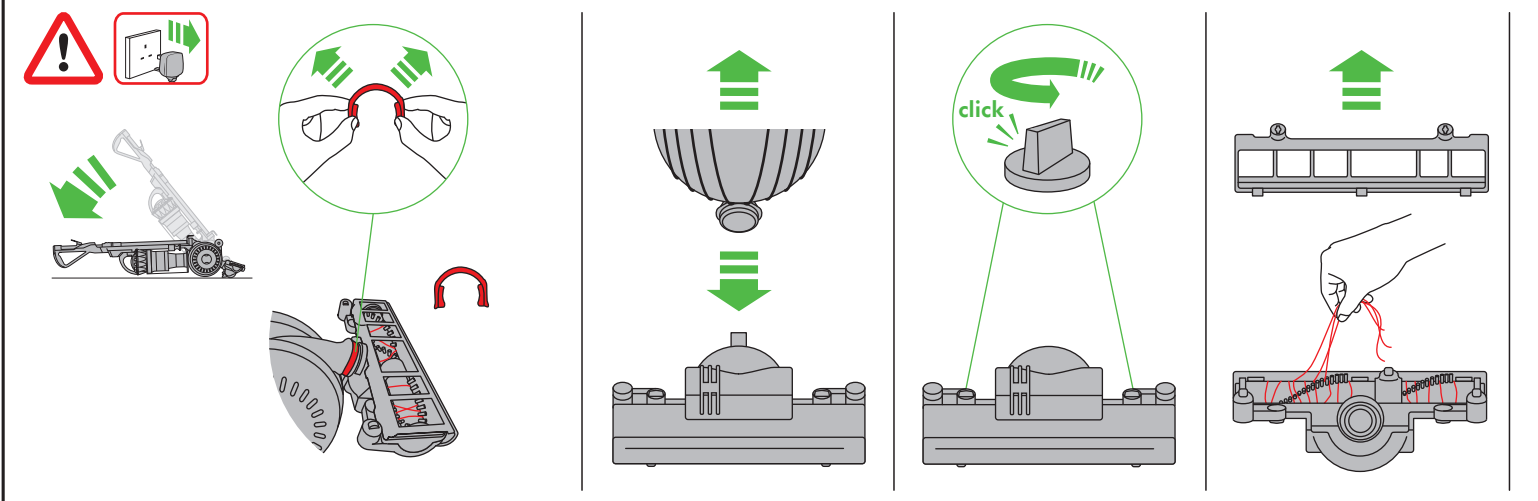



Wash filters with cold water at least every 3 months.
The filters may require more frequent washing if vacuuming fine dust.

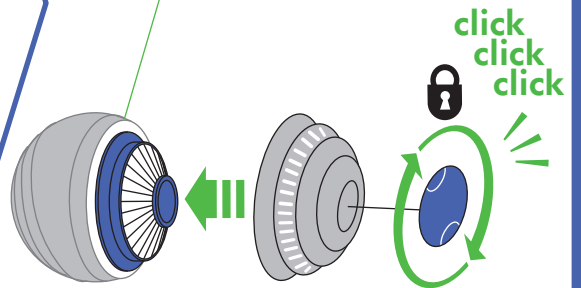
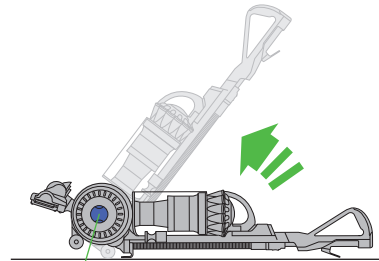
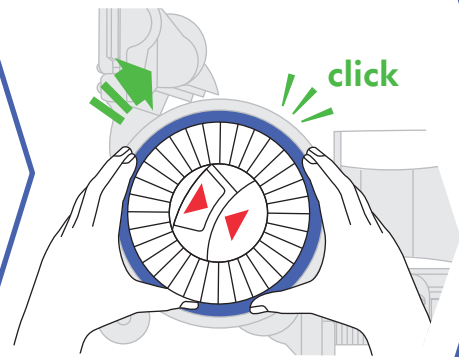
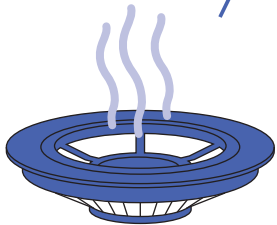
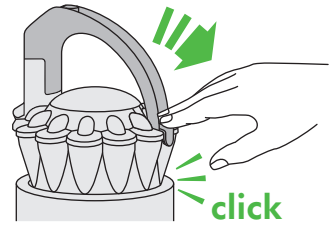
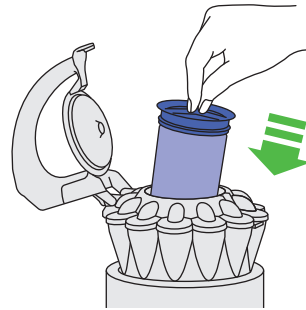
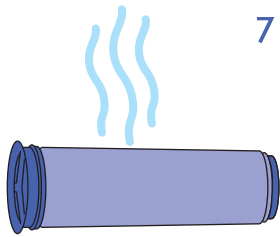

Base plate reassembly

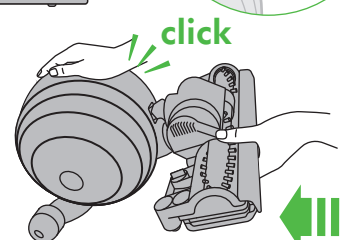
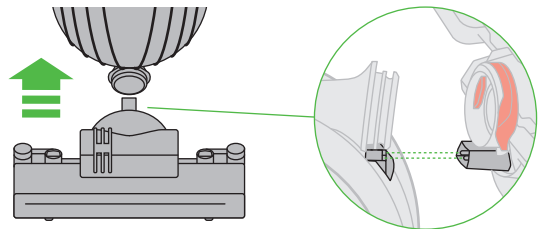
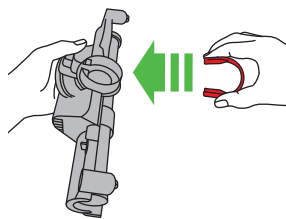
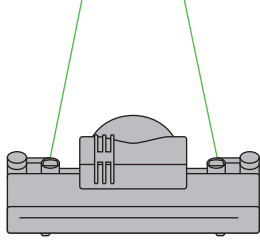
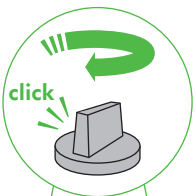
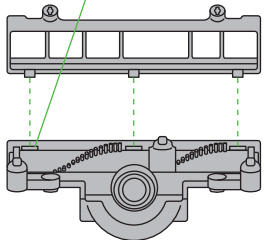
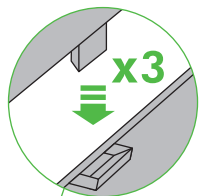

USING YOUR DYSON APPLIANCE

PLEASE READ THE 'IMPORTANT SAFETY INSTRUCTIONS' IN THIS DYSON OPERATING MANUAL BEFORE PROCEEDING.

RATING PLATE

- The rating plate will be either (a) behind the clear bin or (b) on the top of the appliance above the switches, under the wand handle.

ASSEMBLY

- Lie the appliance on its back.
- Attach the cleaner head by sliding it on to the connections on the lower front part of the ball. Ensure the electrical plug on the cleaner head fits into the twin-block connection on the body of the appliance, which is directly above the airway. Push firmly: the cleaner head will click into place.
- Stand the appliance up straight.
- Attach the wand handle by sliding it on to the top of the appliance. The spring clip in the handle will click into place.
- Ensure the hose is straight. Press the red button on the hose. Slide the wand into the hose.
- Ensure the hose and wand sit in the recess of the handle. Slide the end of the wand down into the handle to secure it.
- Close the wand cap.
- Slide the tool holder onto the side of the duct as shown.
- Ensure the cyclone and clear bin unit is secured to the main body of the appliance.
- Attach the tools as shown. In use, the tools can be attached to either the hose or the wand.
- Wind the cable anti-clockwise around the cable hooks. Secure with the clip.
- To watch a short online video visit:
UK – www.dyson.co.uk/DC41gettingstarted
ROI – www.dyson.ie/DC41gettingstarted

OPERATION

- Unwind the cable.
- Plug the appliance into the mains electricity supply.
- To switch 'ON' or 'OFF' press the power button, located as shown.
- To use, recline the handle. The stabiliser stand will automatically lift up.
- After use, return the appliance to the upright position, pushing it firmly into place. The stabiliser wheels will automatically lower.
- Then: unplug, coil the cable safely, put the appliance away.
- Switch 'OFF' the appliance, unplug and ensure it is upright before:
 - changing or using tools
 - removing the hose or airway inspection parts.
- Use the cyclone carry handle to carry the appliance.

ATTACHMENTS

- To release the wand, open the wand cap and pull the red tube up and away from the handle.
- Pull the wand out of the hose until it clicks into place.
- Press the button to release the wand from the hose.

CARPETS OR HARD FLOORS

- The brush bar will always default to 'ON' (spinning) each time you switch the appliance 'ON' and recline it for cleaning.
- The brush bar will not rotate when the appliance is upright.
- To switch the brush bar off (e.g. for hard floors):
 - switch the appliance 'ON'
 - recline the appliance
 - press the brush bar 'ON/OFF' button – the brush bar will stop spinning.
- The brush bar will automatically stop if it becomes obstructed. See 'Brush bar – clearing obstructions'.
- Before vacuuming your flooring, rugs and carpets, check the manufacturer's recommended cleaning instructions.
- Some carpets may fuzz if a rotating brush bar is used when vacuuming. If this happens, we recommend vacuuming in 'hard floor' mode and consulting with the flooring manufacturer.
- The brush bar on the appliance may damage some carpet types. If you are unsure, turn off the brush bar.

LOOKING AFTER YOUR DYSON APPLIANCE

- Do not carry out any maintenance or repair work other than that shown in this Dyson Operating Manual, or advised by the Dyson Helpline.
- Only use parts recommended by Dyson. If you do not this could invalidate your guarantee.
- Store the appliance indoors. Do not use or store it below 0°C (32°F). Ensure the appliance is at room temperature before operating.
- Clean the appliance only with a dry cloth. Do not use any lubricants, cleaning agents, polishes or air fresheners on any part of the appliance.
- If used in a garage, always wipe the soleplate, ball and stabiliser wheels with a dry cloth after vacuuming to clean off any sand, dirt, or pebbles that could damage delicate floors.

VACUUMING



CAUTION:

- Do not use without the clear bin and filters in place.
- Fine dust such as plaster dust or flour should only be vacuumed in very small amounts.
- Do not use the appliance to pick up sharp hard objects, small toys, pins, paper clips, etc. They may damage the appliance.
- When vacuuming, certain carpets may generate small static charges in the clear bin or wand. These are harmless and are not associated with the mains electricity supply. To minimise any effect from this, do not put your hand or insert any object into the clear bin unless you have first emptied it and rinsed it out with cold water (see 'Cleaning the clear bin').
- Powerful suction can cause the hose to 'pull back' – please take care.
- Do not work with the appliance above you on the stairs.
- Do not put the appliance on chairs, tables, etc.
- Before vacuuming highly polished floors, such as wood or lino, first check that the underside of the floor tool and its brushes are free from foreign objects that could cause marking.
- Do not leave the cleaner head in one place on delicate floors.

EMPTYING THE CLEAR BIN

- Empty as soon as the dirt reaches the level of the MAX mark – do not overfill.
- Switch 'OFF' and unplug before emptying the clear bin.
- To remove the cyclone and clear bin unit, press down on the red button at the rear of the carrying handle on the cyclone.
- To release the dirt, press all the way down on the red button at the rear of the carrying handle on the cyclone.
- To minimise dust/allergen contact when emptying, encase the clear bin tightly in a plastic bag and empty.
- Remove the clear bin carefully.
- Seal the bag tightly, dispose as normal.
- To refit:
 - close the clear bin base so it clicks into place
 - push the cyclone and clear bin unit into the main body of the appliance; it will click into place
 - ensure the cyclone and clear bin unit is secure.
- For a free fact sheet visit: www.dyson.co.uk/technology/allergy

CLEANING THE CLEAR BIN

- Remove cyclone and clear bin (instructions above).
- To separate the cyclone unit from the clear bin press the red button to open the clear bin base. This exposes a small silver button behind the red opening mechanism. Press the silver button and separate the cyclone unit from the clear bin.
- Clean the clear bin with cold water only.
- Ensure the clear bin is completely dry before replacing.
- Do not use detergents, polishes or air fresheners to clean the clear bin.
- Do not put clear bin in a dishwasher.
- Do not immerse the whole cyclone unit in water or pour water into it.
- Clean the cyclone shroud with a cloth or dry brush to remove lint and dust.
- To refit:
 - fit the cyclone shroud into the clear bin so that the silver button clicks and engages
 - close the clear bin base so it clicks into place
 - push the cyclone and clear bin unit into the main body of the appliance; it will click into place
 - ensure the cyclone and clear bin unit is secure.

WASHING YOUR FILTERS

- Your appliance has two washable filters, located as shown.
- Check and wash the filters regularly according to instructions to maintain performance.
- Switch 'OFF' and unplug before checking or removing the filters.
- The filters may require more frequent washing if vacuuming fine dust.
- Wash with cold water only. Do not use detergents.
- Do not put the filters in a dishwasher, washing machine, tumble dryer, oven, microwave or near a naked flame.
- After washing lay the filter on its side and leave at least 24 hours to dry completely before refitting.
- To remove filter A see the 'Wash filters' section in this Dyson Operating Manual.
- To remove filter B:
 - turn the central locking dial on the outer cover of the ball anti-clockwise until the cover is released
 - lift off the cover
 - turn the filter one-quarter anti-clockwise to release.
- Filter B should be rinsed and tapped out until the water runs clean, then tapped out again to ensure all excess water is removed. Leave to dry completely for 24 hours.
- It is normal for the filter in the ball to turn grey in colour.
- To refit filter B:
 - refit the filter on to the ball
 - secure the filter by turning it one-quarter turn clockwise.
- When refitting the outer cover of the ball, keep turning the central locking dial clockwise. When it starts to click it is locked.
- To watch a short online video visit:
UK – www.dyson.co.uk/DC41filterwash
ROI – www.dyson.ie/DC41filterwash

LOOKING FOR BLOCKAGES

- Switch 'OFF' and unplug before looking for blockages. Failure to do so could result in personal injury.
- Beware of sharp objects when checking for blockages.
- Refit all parts securely before using.
- Clearing blockages is not covered by your guarantee.

CLEARING BLOCKAGES – THERMAL CUT-OUT

- This appliance is fitted with an automatically resetting thermal cut-out.
- Large items may block the tools or wand inlet. If any part becomes blocked the appliance may overheat and automatically cut-out.
- Switch 'OFF' and unplug. Leave to cool down for 1-2 hours before checking filters or for blockages.
- Clear any blockage before restarting.
- Clearing blockages is not covered by your guarantee.

BRUSH BAR – CLEARING OBSTRUCTIONS

- If your brush bar is obstructed, it may shut off. If this happens, you will need to remove the blockage.
- Switch 'OFF' and unplug before proceeding. Failure to do so could result in personal injury.
- Beware of sharp objects when clearing obstructions.
- If you still cannot clear the obstruction, please follow the instructions below to remove the base plate. This gives more access to the obstruction. Alternatively, contact a Dyson expert on the Dyson Helpline or visit the website. Clearing brush bar obstructions is not covered by your guarantee.

BASE PLATE - DISASSEMBLY/REASSEMBLY

- Switch 'OFF' and unplug before proceeding. Failure to do so could result in personal injury.
- Lie the appliance on its front.
- Detach the red 'C' clip which is on the connection between the cleaner head and the appliance. It is quite firm, but do not pull it off roughly. Use a constant, firm pressure.
- Pull the cleaner head away from the appliance. Use a constant, firm pressure.
- On the cleaner head are two dials: turn each a quarter-turn anti-clockwise until it clicks.
- Put the cleaner head onto its back:
 - lift up the top edge of the base plate, so it rotates to the upright position
 - lift out.
- Beware of sharp objects when clearing obstructions.
- To refit the base plate:
 - fit the 3 lugs on the lower edge of the base plate into the 3 slots in the base of the cleaner head
 - swing the upper edge of the base plate down; it will click into place.
- To secure the base plate:
 - press the base plate close to the cleaner head
 - secure the first dial by turning it a quarter-turn clockwise until it clicks and engages
 - repeat with the second dial.
- Refit the red 'C' clip onto the cleaner head. The flatter edge of the clip fits against the cleaner head. It is easier to slide one lug into its slot before the other.
- Lie the appliance on its back.
- Attach the cleaner head by sliding it on to the connections on the lower front part of the ball. Ensure the electrical plug on the cleaner head fits into the twin-block connection on the body of the appliance, which is directly above the airway. Push firmly: the cleaner head will click into place.

BRUSH BAR – TROUBLESHOOTING

If the brush bar has stopped spinning, follow the instructions above on clearing obstructions. Alternatively, contact a Dyson expert on the Dyson Helpline or visit the website.

- Your serial number is on the rating plate which will be either (a) behind the clear bin or (b) on the top of the appliance above the switches, under the wand handle. To access the rating plate if the wand handle has been fitted:
 - open the wand cap and pull the red tube up and away from the handle.
 - press in the black clip in the recess of the duct.
 - pull the wand handle up and off the appliance; use a constant, firm pressure.
- To watch a short online video visit:
UK – www.dyson.co.uk/DC41brushbarmaintenance
ROI – www.dyson.ie/DC41brushbarmaintenance

DISPOSAL INFORMATION

Dyson products are made from high grade recyclable materials. Please dispose of this product responsibly and recycle where possible.

GUARANTEE TERMS & CONDITIONS

DYSON CUSTOMER CARE

THANK YOU FOR CHOOSING TO BUY A DYSON APPLIANCE

After registering your free 5 year guarantee, your Dyson appliance will be covered for parts and labour for 5 years from the date of purchase, subject to the terms of the guarantee.

If you have any questions about your Dyson appliance, call the Dyson Helpline with your serial number and details of where/when you bought the appliance. Most questions can be solved over the phone by one of our trained Dyson Helpline staff.

Alternatively, visit www.dyson.co.uk/support for online help, general tips and useful information about Dyson.

If your Dyson appliance needs a service, call the Dyson Helpline so we can discuss the available options. If your Dyson appliance is under guarantee, and the repair is covered, it will be repaired at no cost.

Your serial number is on the rating plate which will be either (a) behind the clear bin or (b) on the top of the appliance above the switches, under the wand handle.

PLEASE REGISTER AS A DYSON APPLIANCE OWNER

To help us ensure you receive prompt and efficient service, please register as a Dyson appliance owner. There are three ways to do this:

- Online at www.dyson.co.uk/register
 - Telephone the Dyson Helpline.
 - Complete the enclosed form and post it to us.
- This will confirm ownership of your Dyson appliance in the event of an insurance loss, and enable us to contact you if necessary.

LIMITED 5 YEAR GUARANTEE

TERMS AND CONDITIONS OF THE DYSON 5 YEAR LIMITED GUARANTEE.

WHAT IS COVERED

- The repair or replacement of your Dyson appliance (at Dyson's discretion) if it is found to be defective due to faulty materials, workmanship or function within 5 years of purchase or delivery (if any part is no longer available or out of manufacture Dyson will replace it with a functional replacement part).
- Use of the Dyson appliance in the country of purchase only.

WHAT IS NOT COVERED

Dyson does not guarantee the repair or replacement of a product as a result of:

- Accidental damage, faults caused by negligent use or care, misuse, neglect, careless operation or handling of the appliance which is not in accordance with the Dyson Operating Manual.
 - Use of the appliance for anything other than normal domestic household purposes.
 - Use of parts not assembled or installed in accordance with the instructions of Dyson.
 - Use of parts and accessories which are not genuine Dyson components.
 - Faulty installation (except where installed by Dyson).
 - Repairs or alterations carried out by parties other than Dyson or its authorised agents.
 - Blockages – please refer to the Dyson Operating Manual for details of how to look for and clear blockages.
 - Normal wear and tear (e.g. fuse, brush bar, etc).
- If you are in any doubt as to what is covered by your guarantee, please contact Dyson.

SUMMARY OF COVER

- The guarantee becomes effective at the date of purchase (or the date of delivery if this is later).
- You must provide proof of (both the original and any subsequent) delivery/purchase before any work can be carried out on your Dyson appliance. Without this proof, any work carried out will be chargeable. Keep your receipt or delivery note.
- All work will be carried out by Dyson or its authorised agents.
- Any parts which are replaced will become the property of Dyson.
- The repair or replacement of your Dyson appliance under guarantee will not extend the period of guarantee.
- The guarantee provides benefits which are additional to and do not affect your statutory rights as a consumer.

ABOUT YOUR PRIVACY

- Your information will be held by Dyson Limited and its agents for promotional, marketing and servicing purposes.
- If your personal details change, if you change your mind about any of your marketing preferences or if you have any queries about how we use your information, please contact Dyson Limited.
- For more information on how we protect your privacy, please see our privacy policy on the Dyson website.

DYSON CONTACT DETAILS

Website: www.dyson.com/support

UK:

Dyson Helpline: UK: 0800 298 0298

Open 7am–10pm. 7 days a week.

Email: askdyson@dyson.co.uk

Address: Dyson Limited, Tetbury Hill, Malmesbury, Wiltshire SN16 0RP England.

ROI:

Dyson Helpline: ROI: 01 475 7109

Open 7am–10pm. 7 days a week.

Email: askdyson@dyson.co.uk

Address: Unit 10, Grants Lane, Greenogue Business Park, Rathcoole, Dublin 24.

PRODUCT INFORMATION

Please note: Small details may vary from those shown.

IMPORTANT!

WASH FILTERS



Wash filters with cold water at least every 3 months.
The filters may require more frequent washing if vacuuming fine dust.



Dyson Customer Care

After registering your free 5 year guarantee, your Dyson appliance will be covered for parts and labour for 5 years from the date of purchase, subject to the terms of the guarantee.

If you have any questions about your Dyson appliance, call the Dyson Helpline with your serial number and details of where/when you bought the appliance.

Most questions can be solved over the phone by one of our trained Dyson Helpline staff.

DYSON CONTACT DETAILS

Website: www.dyson.co.uk/support

UK:

Dyson Helpline: UK: 0800 298 0298

Open 7am–10pm. 7 days a week.

Email: askdyson@dyson.co.uk

Address: Dyson Limited, Tetbury Hill, Malmesbury, Wiltshire SN16 0RP England.

ROI:

Dyson Helpline: ROI: 01 475 7109

Open 7am–10pm. 7 days a week.

Email: askdyson@dyson.co.uk

Address: Unit 10, Grants Lane, Greenogue Business Park, Rathcoole, Dublin 24.



Serial number

Date of purchase / / Country of purchase UK ROI

Title Surname

First name

Address

Postcode

email

Telephone Mobile

As a Dyson appliance owner, you can hear about Dyson inventions, services and products before anyone else. If it's okay to contact you, please let us know how we may do this.

We sometimes ask other companies (such as market researchers) to contact owners on our behalf. We do this to get feedback on ideas or ask you to try new products and services. Would this be okay?

By mail Yes No

By phone Yes No

By email Yes No

By text message Yes No

Yes No

3 EASY WAYS TO REGISTER FOR YOUR FREE 5 YEAR GUARANTEE



REGISTER ONLINE

Visit our website to register your full parts and labour guarantee online.

www.dyson.co.uk/register
www.dyson.ie/register



REGISTER BY PHONE

Call our dedicated Helpline Open 7am–10pm. 7 days a week.

UK 0800 298 0298
ROI 01 475 7109



REGISTER BY MAIL

Complete and return the form to Dyson in the envelope supplied.

