

Assembly

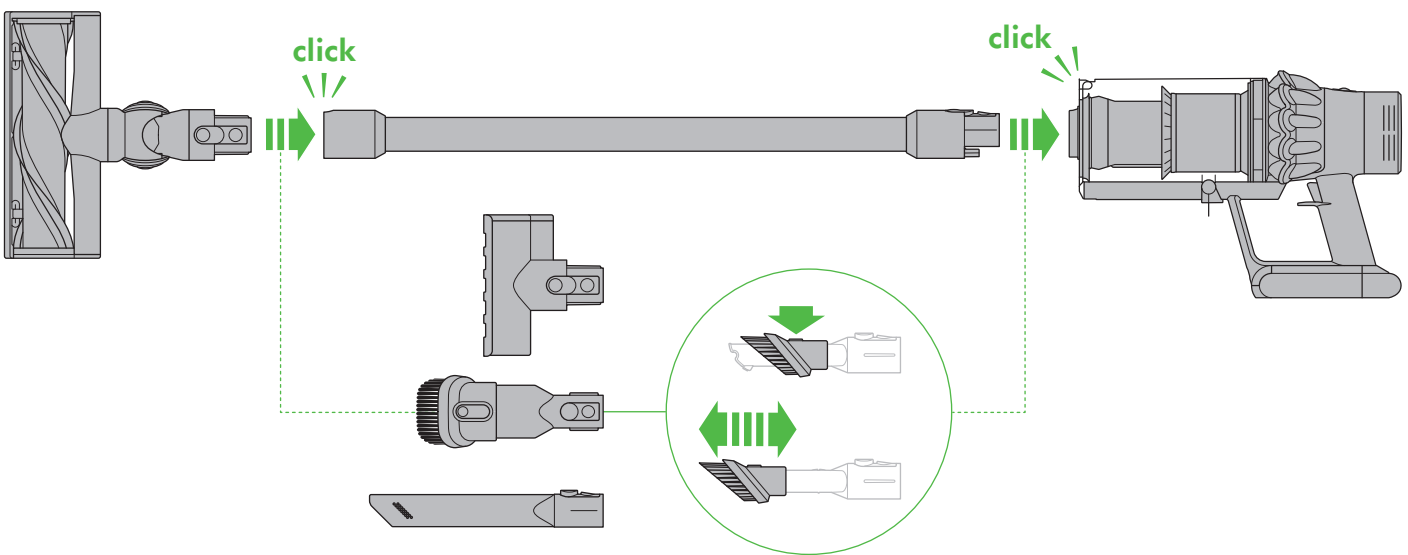

Wash filter unit

Wash filter with cold water at least once every month. Ensure the filter is completely dry before refitting.

The diagram shows the motor unit with a battery level gauge. The gauge is a semi-circle with numbers 1 through 12. A green arrow points from 12 to 3, with "3.5 hrs" written next to it. A charging icon is shown in the top left corner.

Register your free 2 year guarantee today

The diagram shows the motor unit with three suction mode buttons. Each button has "MAX" written above it. The buttons are labeled:

- Maximum suction
- Suction mode 2
- Suction mode 1

Dyson customer care

Thank you for choosing to buy a Dyson appliance

After registering your 2 year guarantee, your Dyson appliance will be covered for parts and labour for 2 years from the date of purchase, subject to the terms of the guarantee.

If you have any queries regarding your Dyson appliance, visit www.dyson.co.uk/support (UK) or www.dyson.ie/support (ROI) for online help, general tips and useful information about Dyson.

Alternatively, you can call the Dyson helpline with your serial number and details of where/when you bought the appliance.

Your serial number can be found on your rating plate which is on the base of the appliance.

Note your serial number for future reference.



This illustration is for example purposes only.

Dyson contact details

UK:
Website: www.dyson.co.uk/support
Dyson helpline: 0800 298 0298
Email: askdyson@dyson.co.uk
Address: Dyson Technology Limited, Tetbury Hill, Malmesbury, Wiltshire, SN16 0RP

ROI:
Website: www.dyson.ie/support
Dyson helpline: 01 475 7109
Email: askdyson@dyson.ie
Address: Dyson Ireland Limited, Unit G10, Grants Lane, Greenogue Business Park, Rathcoole, Dublin 24

IMPORTANT SAFETY INSTRUCTIONS

BEFORE USING THIS APPLIANCE READ ALL INSTRUCTIONS AND CAUTIONARY MARKINGS IN THIS MANUAL AND ON THE APPLIANCE

When using an electrical appliance, basic precautions should always be followed, including the following:

WARNING

These warnings apply to the appliance, and also where applicable, to all tools, accessories, chargers or mains adaptors. **TO REDUCE THE RISK OF FIRE, ELECTRIC SHOCK OR INJURY:**

1. This Dyson appliance can be used by children aged from 8 years and above and persons with reduced physical, sensory or reasoning capabilities, or lack of experience and knowledge, only if they have been given supervision or instruction by a responsible person concerning use of the appliance in a safe way and understand the hazards involved. Cleaning and user maintenance should not be performed by children without supervision.
2. Do not allow to be used as a toy. Close attention is necessary when used by or near children. Children should be supervised to ensure that they do not play with the appliance.
3. Use only as described in this Dyson Operating Manual. Do not carry out any maintenance other than that shown in this manual, or advised by the Dyson Helpline.
4. Suitable for dry locations ONLY. Do not use outdoors or on wet surfaces.
5. Do not handle any part of the plug or appliance with wet hands.
6. Do not use with a damaged cable or plug. If the supply cable is damaged it must be replaced by Dyson, its service agent or similarly qualified person in order to avoid a hazard.

7. If the appliance is not working as it should, has received a sharp blow, has been dropped, damaged, left outdoors, or dropped into water, do not use and contact the Dyson Helpline.
8. Contact the Dyson Helpline when service or repair is required. Do not disassemble the appliance as incorrect reassembly may result in an electric shock or fire.
9. Do not stretch the cable or place the cable under strain. Keep the cable away from heated surfaces. Do not close a door on the cable, or pull the cable around sharp edges or corners. Arrange the cable away from traffic areas and where it will not be stepped on or tripped over. Do not run over the cable.
10. Do not unplug by pulling on the cable. To unplug, grasp the plug, not the cable. The use of an extension cable is not recommended.
11. Do not use to pick up water.
12. Do not use to pick up flammable or combustible liquids, such as petrol, or use in areas where they or their vapours may be present.
13. Do not pick up anything that is burning or smoking, such as cigarettes, matches, or hot ashes.
14. Keep hair, loose clothing, fingers, and all parts of the body away from openings and moving parts, such as the brush bar. Do not point the hose, wand or tools at your eyes or ears or put them in your mouth.
15. Do not put any object into openings. Do not use with any opening blocked; keep free of dust, lint, hair and anything that may reduce airflow.
16. Use only Dyson recommended accessories and replacement parts.
17. Do not use without the clear bin and filter in place.
18. Unplug when not in use for extended periods and before maintenance or servicing.
19. Use extra care when cleaning on stairs.
20. Do not install, charge or use this appliance outdoors, in a bathroom or within 3 metres (10 feet) of a pool. Do not use on wet surfaces and do not expose to moisture, rain or snow.
21. Use only Dyson chargers for charging this Dyson appliance. Use only Dyson batteries: other types of batteries may burst, causing injury to persons and damage.
22. FIRE WARNING – Do not place this product on or near a cooker or any other hot surface and do not incinerate this appliance even if it is severely damaged. The battery might catch fire or explode.
23. Always turn 'OFF' the appliance before connecting or disconnecting the motorised brush bar.
24. FIRE WARNING – Do not apply any fragrance or scented product to the filter(s) of this appliance. The chemicals in such products are known to be flammable and can cause the appliance to catch fire.

READ AND SAVE THESE INSTRUCTIONS

This Dyson appliance is intended for household use only.



Do not use near naked flames.

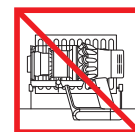

Do not store near heat sources.



Do not pick up water or liquids.



Do not pick up burning objects.



Do not put hands near the brush bar when the appliance is in use.



Do not place on or near the cooker

Power mode

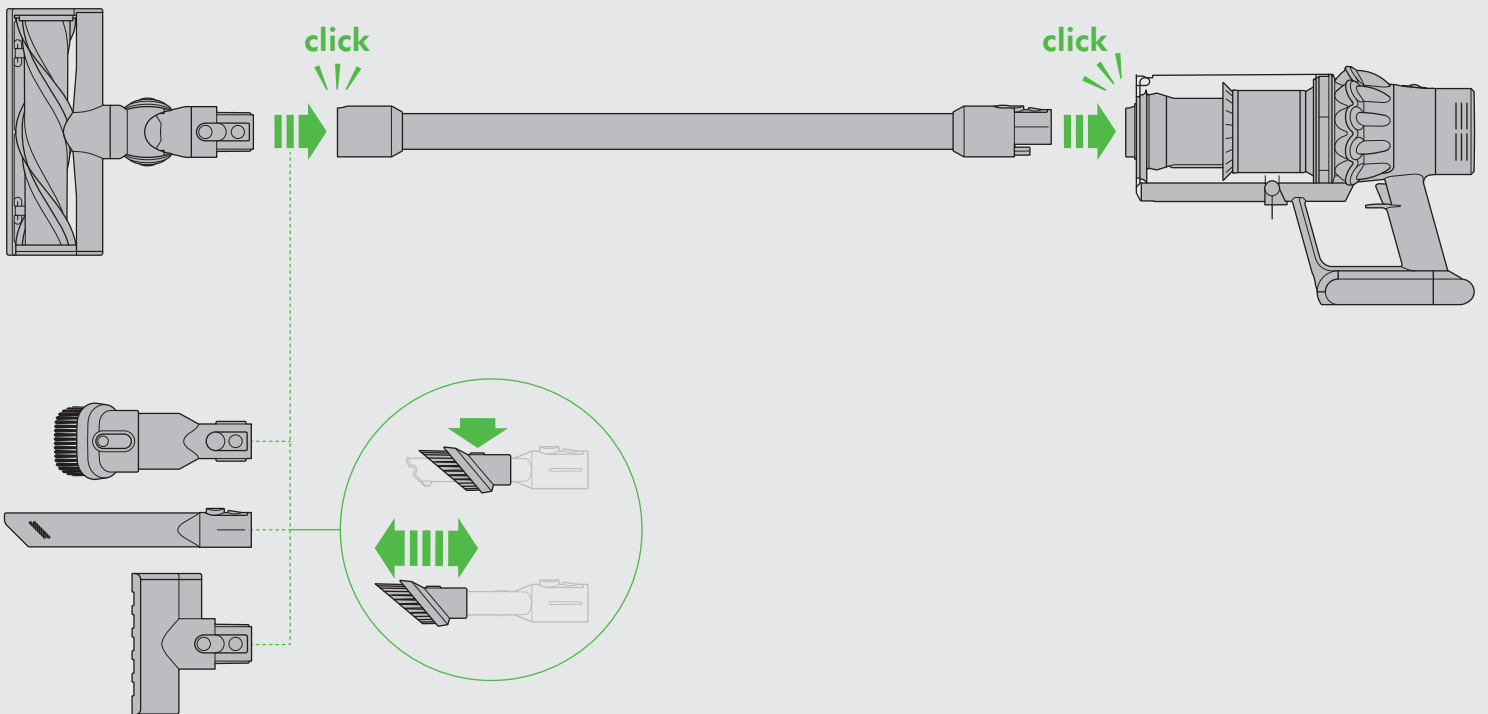
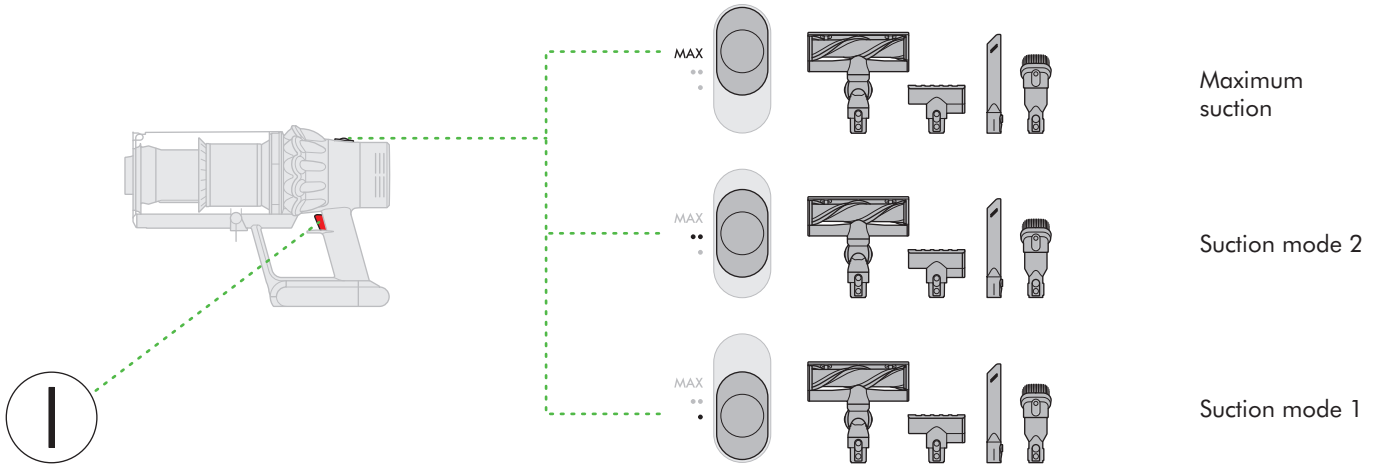

Recharging

Recharging on the dock

Lights during charging

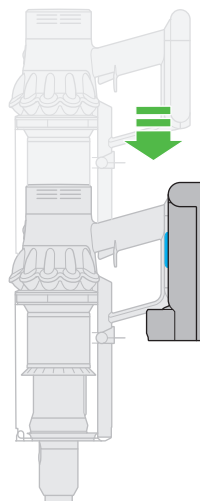
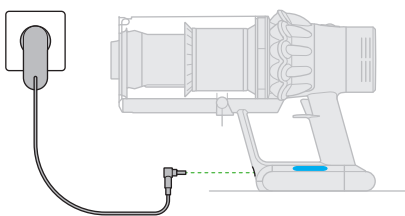
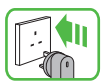

Charging, low charge.



Charging, medium charge.







Charging, nearly full.







Fully charged.

Lights during use

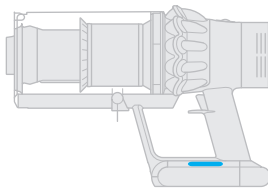
-  High level of charge.
-  Medium level of charge.
-  Low level of charge.
-  Empty, needs charging.



Filter and blockage indicator LEDs

- 
-  Blockage indicator
-  Filter unit requires washing
-  Filter unit not fitted correctly
-  See battery section

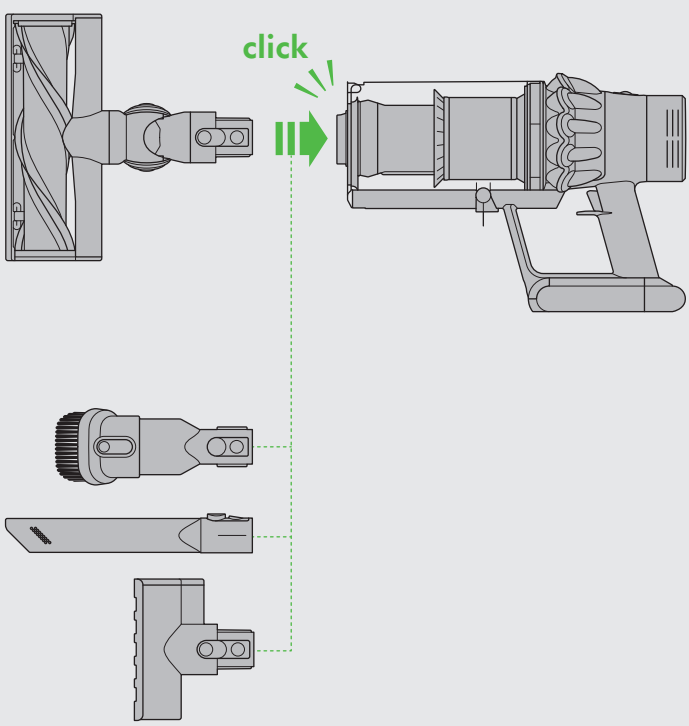
Emptying the clear bin

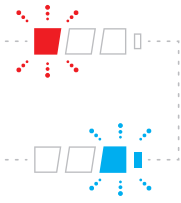

Lights diagnostics

-  Battery fault – call Dyson Helpline
-  Main body fault – call Dyson Helpline
-  Charger fault – call Dyson Helpline



Looking for blockages

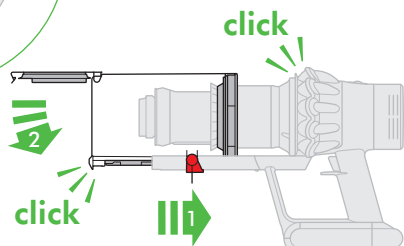
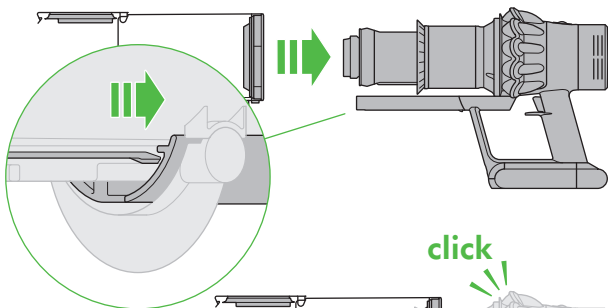
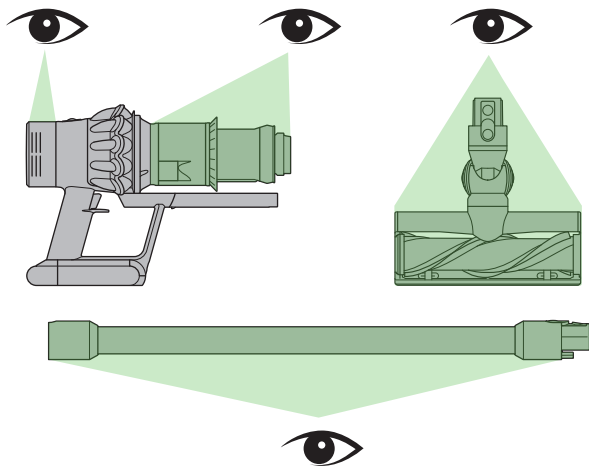
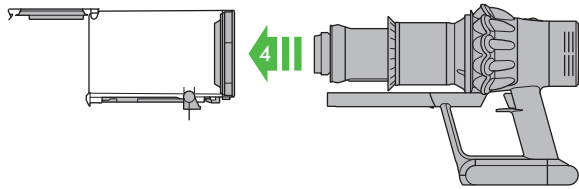
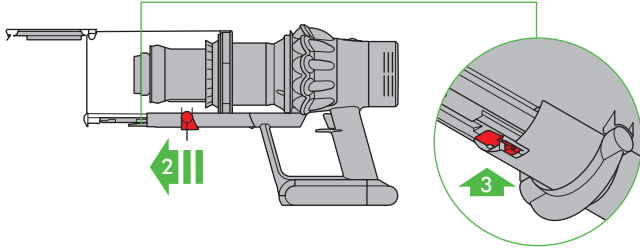
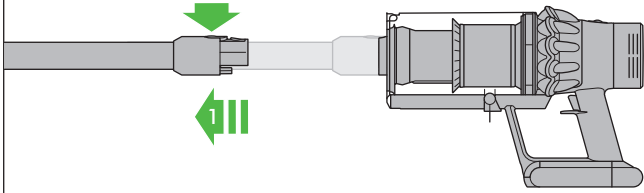

FILTER FILTRE FILTRO

Important

Wash filter with cold water at least once every month.

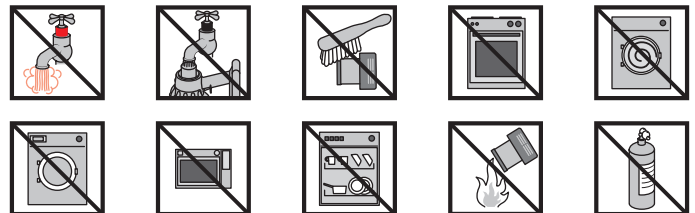
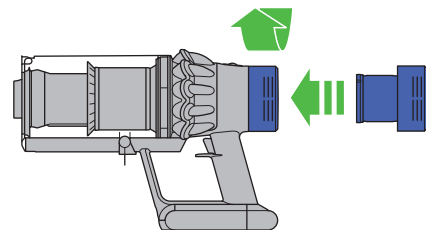
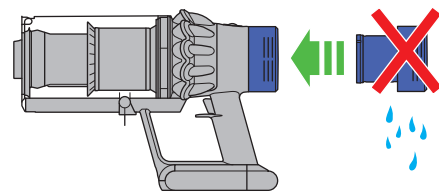
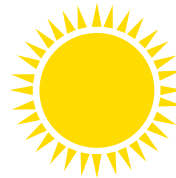
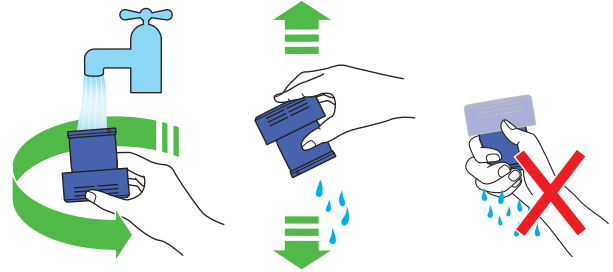
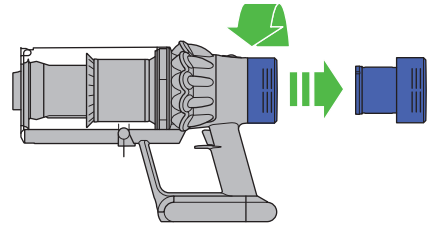

Direct drive cleaner head: Clearing obstructions



1

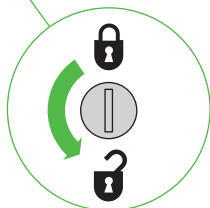

2

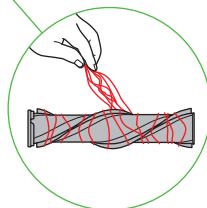
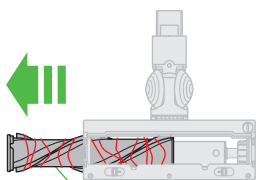

3

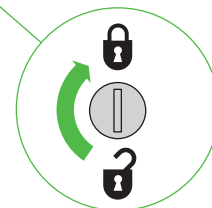
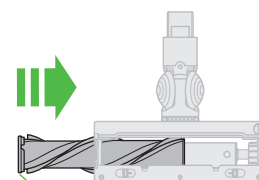

Mini motorised tool: Clearing obstructions



1



2

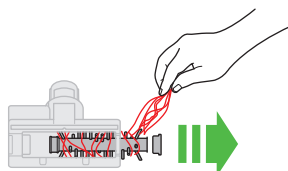

3

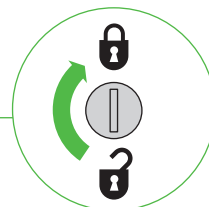
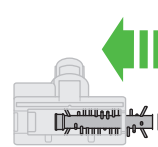

USING YOUR DYSON APPLIANCE

PLEASE READ THE 'IMPORTANT SAFETY INSTRUCTIONS' IN THIS DYSON OPERATING MANUAL BEFORE PROCEEDING.

DOCKING STATION INSTALLATION

- Unpack the docking station, plug and installation leaflet.
 - Select the location for the docking station and ensure that there is no pipework (gas, water or air), electrical cables, wires or ductwork directly behind the mounting location.
 - Follow the instructions on the Installation leaflet.
 - Click the attachments into place.
 - Place the appliance in the docking station.
 - Plug in the docking station and turn on to charge.
 - Your appliance will need to be fully charged before first use.
- The docking station must be mounted in accordance with regulations and applicable codes/standards (state and local laws may apply).
Dyson recommends the use of protective clothing, eyewear and materials when installing the docking station.

VACUUMING

- Remove the appliance from the docking station.
 - Check that the underside of the cleaner head or tool is clean and free from foreign objects that may cause damage.
- Before vacuuming your flooring, rugs and carpets, check the manufacturer's recommended cleaning instructions.
The brush bar on the appliance can damage certain carpet types and floors. Some carpets will fuzz if a rotating brush bar is used when vacuuming. If this happens, we recommend vacuuming without the motorised floor tool and consulting with your flooring manufacturer.

EMPTYING THE CLEAR BIN

- Empty as soon as the dirt reaches the level of the MAX mark – do not overfill. (Please do not use the appliance when the dirt exceeds the MAX line. The dirt will reach the filter, more frequent maintenance of the filter will be required.)
 - Ensure the appliance is disconnected from the charger before emptying the clear bin. Be careful not to pull the 'ON' trigger.
 - Avoid pulling the "ON" trigger when emptying.
 - Remove the wand by pressing the red wand release button and pulling away from the bin.
 - To release the dirt:
 - Hold the appliance with the bin in a downwards position.
 - firmly push the red bin release button.
 - The bin will slide down, cleaning the shroud as it goes.
 - The bin base will then open.
 - The bin base will not open if the red button is not pushed down fully.
- To minimise dust/allergen contact when emptying, encase the clear bin tightly in a plastic bag and empty. Remove the clear bin carefully from the bag. Seal the bag tightly, dispose as normal.

CLEANING THE CLEAR BIN (OPTIONAL)

If it is necessary to clean the clear bin:

- Follow the instructions in the "Emptying the clear bin" section.
 - Press the red button located on the bin runner to release the bin and slide the bin off the runner.
 - Clean the clear bin with a damp cloth only.
 - Ensure that the clear bin and seals are completely dry before replacing.
 - To refit the clear bin:
 - Insert the spine on to the bin runner.
- Close the clear bin by pushing the bin base upwards until the clear bin and bin base click into place.
The clear bin is not dishwasher safe and the use of detergents, polishes or air fresheners to clean the clear bin is not recommended as this may damage to your appliance.

FILTER AND BLOCKAGE INDICATOR LEDS

Your appliance has two indicator lights that will help alert you that simple maintenance steps are needed.

- The filter indicator will flash intermittently when the filter unit is not fitted correctly. Follow the instructions on how to refit the filter unit in the 'Washing the filter unit' section.
- The filter indicator will light continuously when the filter unit needs washing. Follow the instructions on how to wash the filter unit in the 'Washing the filter unit' section.
- The blockage Indicator LED will light if there is a blockage. Follow the instructions on how to clear blockages in the 'Looking for blockages' section.

WASHABLE PARTS

Your appliance has washable parts, which require regular cleaning. Follow the instructions below.

WASHING THE FILTER UNIT

Check and wash the filter unit, according to the instructions, to maintain performance.

- Remove the filter unit by twisting anti-clockwise to the open position. Gently pull away from the appliance.
 - Wash the inside of the filter unit first; hold it upright under the cold water tap and agitate using a rotating motion.
 - Wash the outside of the filter unit; fill the unit with cold water, place your hand over the open end and shake gently.
 - Repeat washing the inside and outside of the filter unit until the water runs clear.
 - Gently tap the filter unit to remove any excess water and leave to dry with the open end facing up.
 - Leave the filter unit to dry completely for a minimum of 24 hours.
 - Check that the filter unit is completely dry.
 - To refit, return the filter unit to the open position and twist clockwise until it clicks into place.
- The filter unit may require more frequent washing if vacuuming fine dust or using mainly maximum suction.
Do not put the filter unit in a dishwasher, washing machine, tumble dryer, oven, microwave or near a naked flame.

BLOCKAGES – AUTOMATIC CUT-OUT

- This appliance is fitted with an automatic cut-out.
- If any part becomes blocked the appliance may automatically cut out.
- This will happen after the motor pulses a number of times (i.e switches on and off in quick succession) and the blockage indicator LED will illuminate.
- Leave to cool down before looking for blockages.
- Ensure the appliance is disconnected from the charger before looking for blockages. Failure to do so could result in personal injury.
- Clear any blockage before restarting.
- Refit all parts securely before using.
- Clearing blockages is not covered by your guarantee.

LOOKING FOR BLOCKAGES

The motor will pulse and the blockage indicator LED will illuminate when there is a blockage. Please follow the instructions below to locate the blockage:

- Ensure the appliance is disconnected from the charger before looking for blockages. Be careful not to pull the 'ON' trigger.
- Do not operate while checking for blockages. Doing so could result in personal injury.
- Beware of sharp objects when checking for blockages.
- To check for blockages in the main body of the appliance, remove the clear bin following the instructions in the cleaning the clear bin section and remove the blockage.
- If you cannot clear an obstruction from the cleanerhead, you may need to remove the brush bar. Use a coin to unlock the fastener, slide the brush bar out of the cleanerhead and remove the obstruction. Replace the brush bar and secure it by tightening the fastener. Ensure it is fixed firmly before operating the appliance.
- This appliance has carbon fibre brushes. Take care if coming into contact with them, as they may cause minor skin irritation. Wash your hands after handling the brushes.
- Refit all parts securely before using.
- Clearing blockages is not covered by your guarantee.

CHARGING AND STORING

- This appliance will switch 'OFF' if the battery temperature is below 3°C (37.4°F). This is designed to protect the motor and battery. Do not charge the appliance and then move it to an area with a temperature below 3°C (37.4°F) for storage purposes.
- To help prolong battery life, avoid recharging immediately after a full discharge. Allow to cool for a few minutes.
- Avoid using the appliance with the battery flush to a surface. This will help it run cooler and prolong battery run time and life.

BATTERY SAFETY INSTRUCTIONS

- If the battery needs replacing please contact the Dyson Helpline.
- Use only Dyson chargers for charging this Dyson appliance.
- The battery is a sealed unit and under normal circumstances poses no safety concerns. In the unlikely event that liquid leaks from the battery do not touch the liquid as it may cause irritation or burns, observe the following precautions:
 - Skin contact – can cause irritation. Wash with soap and water.
 - Inhalation – can cause respiratory irritation. Expose to fresh air and seek medical advice.
 - Eye contact – can cause irritation. Immediately flush eyes thoroughly with water for at least 15 minutes. Seek medical attention.
 - Disposal – wear gloves to handle the battery and dispose of immediately, following local ordinances or regulations.

CAUTION

The battery used in this device may present a risk of fire or chemical burn if mistreated. Do not disassemble, short contacts, heat above 60°C (140°F), or incinerate. Keep away from children. Do not disassemble and do not dispose of in fire.

ONLINE SUPPORT

- For online help, general tips, videos and useful information about Dyson.
UK: www.dyson.co.uk/support
ROI: www.dyson.ie/support

DISPOSAL INFORMATION

- Dyson products are made from high grade recyclable materials. Recycle where possible.
- The battery should be removed from the product before disposal.
- Dispose of or recycle the battery in accordance with local ordinances or regulations.
- Dispose of the exhausted filter unit in accordance with local ordinances or regulations.
- This marking indicates that this product should not be disposed with other household wastes throughout the EU. To prevent possible harm to the environment or human health from uncontrolled waste disposal, recycle it responsibly to promote the sustainable reuse of material resources. To return your used device, please use the return and collection systems or contact the retailer where the product was purchased. They can take this product for environmentally safe recycling.

DYSON CUSTOMER CARE

THANK YOU FOR CHOOSING TO BUY A DYSON APPLIANCE.

After registering your 2 year guarantee, your Dyson appliance will be covered for parts and labour for 2 years from the date of purchase, subject to the terms of the guarantee. If you have any queries regarding your Dyson appliance, visit www.dyson.co.uk/support or www.dyson.ie/support for online help, general tips and useful information about Dyson.

Alternatively, you can call the Dyson Helpline with your serial number and details of where/when you bought the appliance.

If your Dyson appliance needs a repair, call the Dyson Helpline so we can discuss the available options. If your Dyson appliance is under guarantee, and the repair is covered, it will be repaired at no cost.

PLEASE REGISTER AS A DYSON APPLIANCE OWNER

The guarantee for this product is 2 years from the date of purchase. Please register your guarantee within 30 days of your purchase date. To help us ensure you receive prompt and efficient service, please register immediately after purchase. Please keep the receipt showing the date of purchase.

To help us ensure you receive prompt and efficient service, please register as a Dyson appliance owner. There are three ways to do this:

- Online at www.dyson.co.uk/register (UK) or www.dyson.ie/register (ROI).
- Telephone the Dyson Helpline on 0800 298 0298 (UK) or 01 475 7109 (ROI).
- Complete the enclosed form and post it to us.
- By registering online or by phone you will:
 - Protect your investment with a two year parts and labour guarantee.
 - Receive helpful tips on using your machine.
 - Get expert advice from the Dyson Helpline.
 - Be the first to hear about our latest inventions.
- Registering only takes a few minutes and all you need is your serial number.

LIMITED 2 YEAR GUARANTEE

TERMS AND CONDITIONS OF THE DYSON 2 YEAR LIMITED GUARANTEE

WHAT IS COVERED

- The repair or replacement of your Dyson appliance (at Dyson's discretion) if it is found to be defective due to faulty materials, workmanship or function within 2 years of purchase or delivery (if any part is no longer available or out of manufacture Dyson will replace it with a functional replacement part).
- Where this appliance is sold outside of the EU, this guarantee will only be valid if the appliance is used in the country in which it was sold.
- Where this appliance is sold within the EU, this guarantee will only be valid (i) if the appliance is used in the country in which it was sold or (ii) if the appliance is used in Austria, Belgium, France, Germany, Ireland, Italy, Netherlands, Spain or the United Kingdom and the same model as this appliance is sold at the same voltage rating in the relevant country.

WHAT IS NOT COVERED

Dyson does not guarantee the repair or replacement of a product where a defect is the result of:

- Accidental damage, faults caused by negligent use or care, misuse, neglect, carelessness or operation or handling of the appliance which is not in accordance with the Dyson Operating Manual.
 - Use of the appliance for anything other than normal domestic household purposes.
 - Use of parts not assembled or installed in accordance with the instructions of Dyson.
 - Use of parts and accessories which are not genuine Dyson components.
 - Faulty installation (except where installed by Dyson).
 - Repairs or alterations carried out by parties other than Dyson or its authorised agents.
 - Blockages – please refer to the Dyson Operating Manual for details of how to look for and clear blockages.
 - Normal wear and tear (e.g. fuse, brush bar etc.).
 - Use of this appliance on rubble, ash, plaster.
 - Reduction in battery discharge time due to battery age or use (where applicable).
- If you are in any doubt as to what is covered by your guarantee, please contact the Dyson helpline.

SUMMARY OF COVER

- The guarantee becomes effective at the date of purchase (or the date of delivery if this is later).
- You must provide proof of (both the original and any subsequent) delivery/purchase before any work can be carried out on your Dyson appliance. Without this proof, any work carried out will be chargeable. Keep your receipt or delivery note.
- All work will be carried out by Dyson or its authorised agents.
- Any parts which are replaced by Dyson will become the property of Dyson.
- The repair or replacement of your Dyson appliance under guarantee will not extend the period of guarantee.
- The guarantee provides benefits which are additional to and do not affect your statutory rights as a consumer.

IMPORTANT DATA PROTECTION INFORMATION

When registering your Dyson product:

- You will need to provide us with basic contact information to register your product and enable us to support your guarantee.
- When you register, you will have the opportunity to choose whether you would like to receive communications from us. If you opt-in to communications from Dyson, we will send you details of special offers and news of our latest innovations. We never sell your information to third parties and only use information that you share with us as defined by our privacy policies which are available on our website: privacy.dyson.com

IMPORTANT!

Wash filter unit

Wash filter with cold water at least once every month.
Ensure the filter is completely dry before refitting.

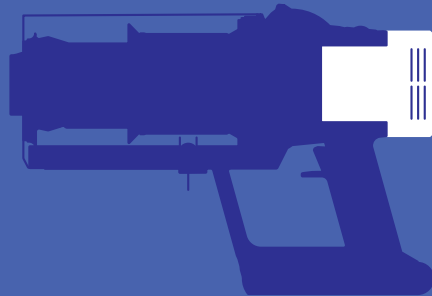

DYSON CUSTOMER CARE

After registering your free 2 year guarantee, your Dyson appliance will be covered for parts and labour for 2 years from the date of purchase, subject to the terms of the guarantee. If you have any questions about your Dyson appliance, call the Dyson Helpline with your serial number and details of where/when you bought the appliance.

Most questions can be solved over the phone by one of our trained Dyson Helpline staff.

Dyson contact details

UK:

Website: www.dyson.co.uk/support

Dyson helpline:

0800 298 0298

Email:

askdyson@dyson.co.uk

Address:

Dyson Technology Limited, Tetbury Hill,
Malmesbury, Wiltshire, SN16 0RP

ROI:

Website: www.dyson.ie/support

Dyson helpline:

01 475 7109

Email:

askdyson@dyson.ie

Address:

Dyson Ireland Limited, Office 2, Central
Park, Leopardstown, Dublin 18, Ireland

Online support

For online help, general tips, videos and useful information about Dyson.

www.dyson.co.uk/support

www.dyson.ie/support



